



Type(s)
Project
Date
Notes

OVERVIEW

Fixture Overview

SolaFrame Studio is a fanless, convection-cooled automated luminaire that prioritizes high quality features, spectral output and silence. When you need an automated lighting product that is audibly invisible and visually impactful, the SolaFrame Studio is the right choice. With a feature set designed for exquisite projection control and beautiful color rendering, SolaFrame Studio can quietly steal the scene.

Applications

- Theatres of all sizes
- Concert halls
- Opera houses
- Film and television broadcast studios
- Churches and houses of worship

Product Features

- Bright white LED engine
- 300 W High CRI engine producing 10,000 field lumens
- Color-matched convection-cooled engine for completely fanless operation.
- High quality 13-lens optic system with patented Lens Defogger
- Extremely powerful 5.5°–57° zoom
- CMY/CTO-Linear color mixing system
- Seven position plus open replaceable Color Wheel
- Full-curtain framing system for total control of beam shaping
- 16-blade iris for extremely tight beam effects
- Light diffusion with additional, optional heavy diffusion
- Seven position plus open Rotating Gobo Wheel
- Linear rotating prism for controlled pattern replication across a stage

ORDERING INFORMATION

SolaFrame Studio

| Model | Description |
|-----------|--|
| 2560A1211 | SolaFrame Studio, High CRI, black with styrofoam packaging |

Color Options: Fixtures ship standard in black. White available by request.
Included Accessories: Fixture includes two (2) Omega brackets, one (1) fixture power cord, bare ends to powerCON® TRUE1® input, and a safety cable.

Accessories

| Model | Description |
|-----------|---|
| 2560A2083 | Optional Heavy Frost for Prism arm mounting |
| 2560B7009 | Fixture Power Cord upgrade, 5-15 Edison to powerCON TRUE1, 15 A |
| 2560B7005 | Fixture Power Cord upgrade, Stage Pin to powerCON TRUE1, 20 A |
| 2560B7006 | Fixture Power Cord upgrade, L6-20 to powerCON TRUE1, 20 A |
| 2560B7007 | Fixture Power Cord upgrade, L5-20 to powerCON TRUE1, 20 A |
| 67040007 | MegaClaw™ |
| 55040014 | Cheeseborough 2" Alloy 1/2 Coupler Truss Clamp |
| 67040010 | Mini-Claw™ |



PRODUCT SPECIFICATIONS

Source

| | |
|---------------------------|-----------------------|
| Engine | Bright White High CRI |
| LED Details | 300 W |
| Max Field Lumens | 9,900 lumens |
| Integrating Sphere Lumens | 10,100 lumens |
| LPW | 32.9 |
| LED Life | 50,000 hours |
| Native CCT | 5700 K |
| Transferable Light Engine | Yes |

Color

| | |
|-------------------|--|
| Color Mixing | Cyan, magenta, yellow, CTO-linear |
| Color Temperature | Variable down to 2800 K |
| Color Wheel | Seven (7) interchangeable dichroic chips plus open |

Optical

| | |
|--------------------------|--|
| Beam Angle Range | 5.5°–57° |
| Gate Size | 22 mm (7/8 in) |
| Aperture Size | 127 mm (5.0 in) |
| Pattern Projection | Rotating and indexable wheel with seven (7) patterns plus open |
| Animation | Bi-directional animation wheel LED animation |
| Prism | Four facet linear rotating prism |
| Frost | Light frost and heavy frost optional in place of prism |
| Iris | 16-blade iris |
| Framing | Four-plane, full-curtain framing system with 90° module rotation |
| Flicker Control/Hz Range | 2.4 kHz or 16 kHz |

Control

| | |
|---------------------|--|
| Input Method | DMX (5-pin) or Ethernet |
| Protocols | DMX via RS-485 Art-Net or sACN via Ethernet |
| Ethernet Pass-Thru | Passive Ethernet in and thru with and without power |
| Data Conversion | Patented data conversion system for: DMX to Ethernet Ethernet to DMX |
| Modes (Footprint) | Standard or Dual Frost (48 channels) |
| RDM Functions | Yes |
| UI Type | Full color graphical UI with 6-button navigational control |
| Local Control | Yes |
| Dimming Performance | 16-bit, DMX controlled |

Electrical

| | |
|---------------|---------------------|
| Voltage Range | 100–240 V, 50–60 Hz |
| Input Method | powerCON TRUE1 |
| Wattage (Max) | 608 W |
| Current (Max) | 6.1 A @ 100 V |

Thermal

| | |
|------------------------|---|
| Ambient Operating Temp | -10°–35°C (14°–95°F) |
| Fan Mode | Fanless, Convection-cooled |
| Stationary Noise | 23 dBA at full intensity (16.3 dBA background noise) |

Physical

| | |
|----------------------|---|
| Pan and Tilt Range | 540° pan, 270° tilt |
| Max Pan/Tilt Speed | 360° in 2.75 s / 180° in 1.7 s |
| Materials | Steel and aluminum frame with molded plastic covers |
| Color Options | Black, white by request |
| Mounting Options | Any orientation |
| IP Rating | IP20 |
| Weight | 34 kg (75 lb) |
| Included Accessories | powerCON TRUE1 to bare end fixture tail Two (2) clamp brackets Safety cable |

Warranty

| | |
|------------------|---|
| Fixture Warranty | Five (5) year for light engine Two (2) year for complete fixture |
| Warranty Details | highend.com/warranty |

Regulatory & Compliance

| | |
|---|---|
| Regulatory Standards | Listed to UL 1573 Certified to CSA STD. C22.2 No: 166 EAC |
| CE compliance declared to these standards | Safety: EN 60598-1, EN 60598-2-17, EN 62031, EN 62471 EMC: EN 55015, EN 61547, EN 61000-3-2, EN 6100-3-3 |
| Complies to the ROHS directive | Yes |

Safety

| | |
|--------|---|
| Safety | Minimum distance to illuminated surface = 2.0 m (6.5 ft) Minimum distance from fixture head to combustible materials = 0.1 m (0.33 ft) |
|--------|---|

Notes: All LED sources experience some lessening of light output and some color shift over time. LED output will vary with thermal conditions. Thermal conditions can be affected by ambient temperatures and orientation.

FEATURE DETAILS

Rotating Gobo Details







| | |
|------------------|--|
| Outside Diameter | 25 mm (0.98 in) |
| Image Diameter | 20 mm (0.78 in) |
| Materials | 0.5 mm aluminum 1.1 mm glass Borofloat® |

Color Wheel Details

| | |
|-----------|------------------------|
| Shape | Interchangeable wedge |
| Materials | 1.1 mm glass Borofloat |

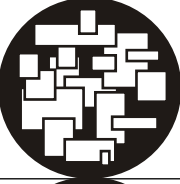
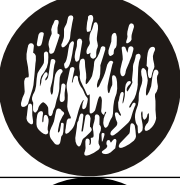
Animation Wheel Details

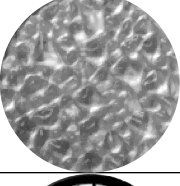
| | |
|-----------|------------------------------------|
| Movement | Bi-directional continuous rotation |
| Materials | 0.6 mm aluminum |

| | |
|--|---------------------|
|  | 1 - Fracture |
|  | 2 - Polymoba |
|  | 3 - Modern |
|  | 4 - Fire |
|  | 5 - Crescents |
|  | 6 - Ice |
|  | 7 - Foliage (Glass) |

| | |
|---|--------------|
|  | 1 - Red |
|  | 2 - Blue |
|  | 3 - Green |
|  | 4 - Yellow |
|  | 5 - Orange |
|  | 6 -Purple |
|  | 7- Dark Blue |

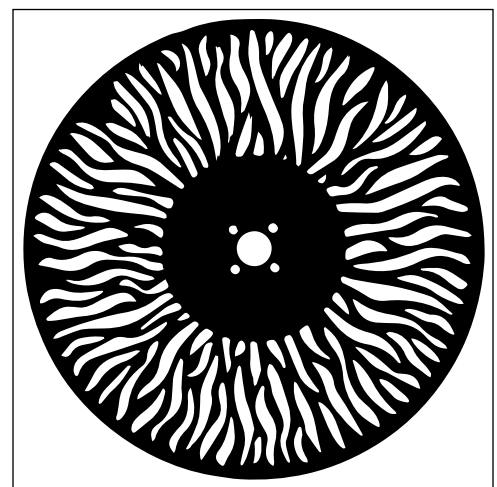

PHOTOMETRIC DATA

SolaFrame Studio - High CRI

| | Degree | Candela | Field Lumens | Power Usage | Lumens Per Watt |
|--------|--------|---------|--------------|-------------|-----------------|
| Narrow | 5.5° | 752,800 | 5,584 | 300 W | 19 |
| Medium | 26° | 77,700 | 9,051 | 300 W | 31 |
| Wide | 57° | 18,200 | 9,895 | 300 W | 33 |

Narrow - 5.5°

| | | | | | |
|-------------------|-----------------|------------------|------------------|------------------|-------------------|
| Throw Distance | 10 ft 3.0 m | 20 ft 6.1 m | 30 ft 9.1 m | 50 ft 15.2 m | 200 ft 61 m |
| Field Diameter | 1.0 ft 0.3 m | 1.9 ft 0.59 m | 2.9 ft 0.88 m | 4.8 ft 1.47 m | 19.2 ft 5.86 m |
| Illuminance (fc) | 7,528 | 1,882 | 837 | 302 | 19 |
| Illuminance (lux) | 81,000 | 20,250 | 9,000 | 3,240 | 203 |

Medium - 26°

| | | | | | |
|-------------------|------------------|------------------|-------------------|-------------------|--------------------|
| Throw Distance | 10 ft 3.0 m | 20 ft 6.1 m | 30 ft 9.1 m | 50 ft 15.2 m | 200 ft 61 m |
| Field Diameter | 4.6 ft 1.41 m | 9.2 ft 2.82 m | 13.9 ft 4.23 m | 23.1 ft 7.04 m | 92.3 ft 28.15 m |
| Illuminance (fc) | 777 | 195 | 87 | 32 | 2 |
| Illuminance (lux) | 8,360 | 2,090 | 929 | 334 | 21 |

Wide - 57°

| | | | | | |
|-------------------|-------------------|-------------------|-------------------|--------------------|---------------------|
| Throw Distance | 10 ft 3.0 m | 20 ft 6.1 m | 30 ft 9.1 m | 50 ft 15.2 m | 200 ft 61 m |
| Field Diameter | 10.9 ft 3.31 m | 21.7 ft 6.62 m | 32.6 ft 9.93 m | 54.3 ft 16.55 m | 217.2 ft 66.20 m |
| Illuminance (fc) | 182 | 46 | 21 | 8 | 1 |
| Illuminance (lux) | 1,958 | 490 | 218 | 78 | 5 |

To determine center beam illumination in footcandles at any throw distance, divide candela by the throw distance squared.

Metric conversions: For meters, multiply feet by 0.3048.
For lux, multiply footcandles by 10.76.

SolaFrame Studio - Spectral Data

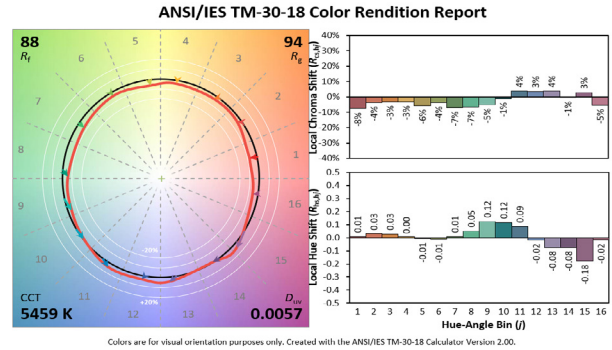

Additional Color Metrics

| | |
|--------------------------------------|---------|
| CRI R _a (R _g) | 90 (47) |
| TLCI | 89 |

PHYSICAL INFORMATION

SolaFrame Studio Dimensions

| Model | Height | | Width | | Depth | | Weight | |
|--------------------------------------|--------|-----|-------|-----|-------|-----|--------|----|
| | in | mm | in | mm | in | mm | lb | kg |
| SolaFrame Studio* | 29.3 | 744 | 18.6 | 473 | 12.9 | 327 | 75 | 34 |
| SolaFrame Studio with foam packaging | 33 | 838 | 24 | 610 | 18 | 457 | 90 | 41 |

*Does not include mounting hardware

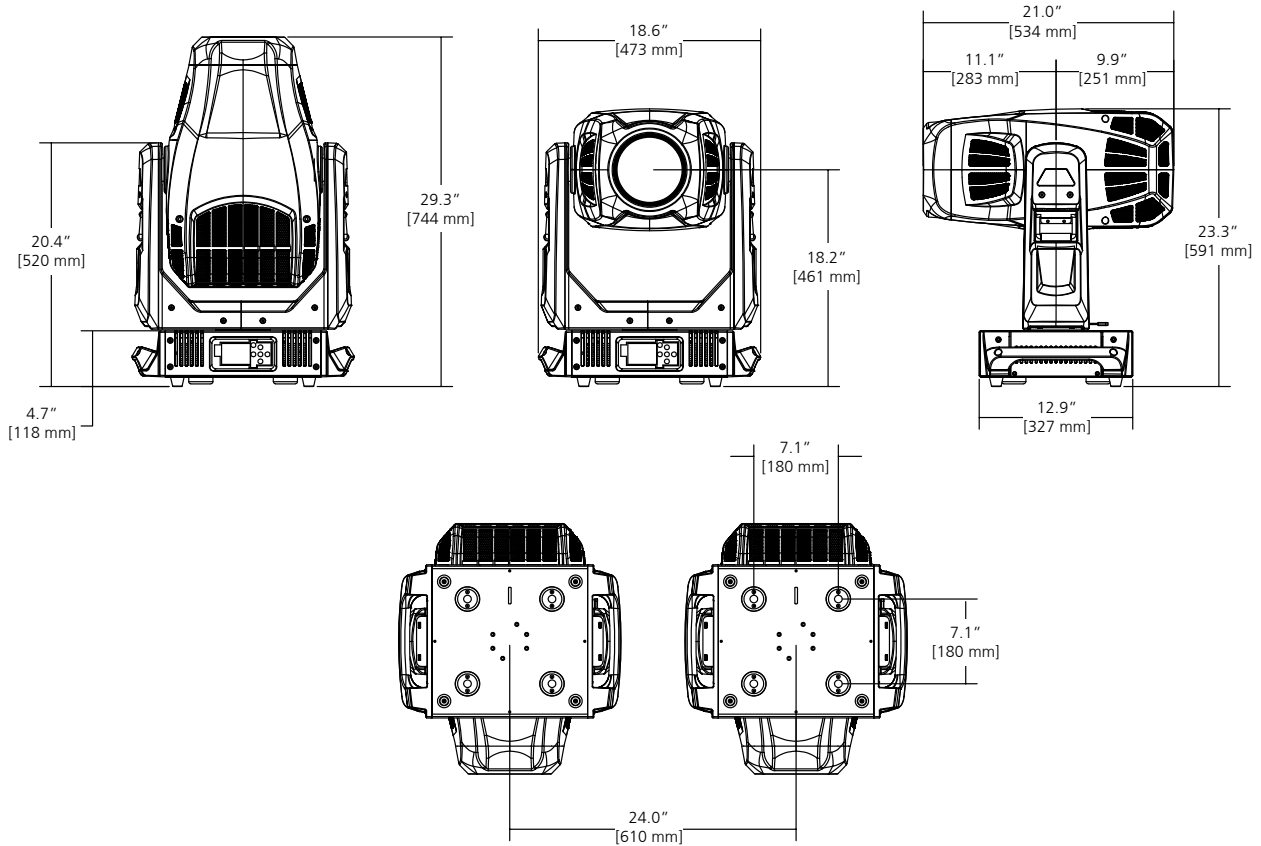

Power Table

| VAC | Amps | Hz | Watts | VA | PF |
|-----|------|----|-------|-----|------|
| 100 | 6.3 | 50 | 629 | 628 | 0.99 |
| 120 | 5.2 | 60 | 614 | 619 | 0.99 |
| 200 | 3.0 | 50 | 588 | 610 | 0.97 |
| 208 | 2.9 | 60 | 587 | 604 | 0.97 |
| 220 | 2.8 | 50 | 586 | 613 | 0.96 |
| 230 | 2.7 | 50 | 592 | 615 | 0.96 |
| 240 | 2.5 | 60 | 585 | 607 | 0.96 |



Corporate Headquarters • Middleton, WI USA
 Global Offices • London, UK • Rome, IT • Holzkirchen, DE • Paris, FR • Hong Kong • Dubai, UAE • Singapore • New York, NY • Orlando, FL • Los Angeles, CA

Copyright©2021 ETC. All Rights Reserved. All product information and specifications subject to change. Rev C 2021-01
 Trademark and patent info: etconnect.com/IP

etconnect.com