

# ZEP2 - 644SX2 WW

6405X - LED 150 W



- **Type:** Profile spot
- **Source:** LED 150 W
- **Optics:** 16° to 35° zoom
- **Colour temperature:** Warm white

Profile spot

## The LED profile combining power and optical excellence

The RJ ZEP2 profile incorporates an innovative and powerful 150 W LED engine, designed to offer a higher light quality and output - equivalent to a 1000 W tungsten profile spot - together with very low power consumption. Designed with Robert Juliat's trademark qualities of ergonomic perfection, optical and mechanical excellence, ZEP2 features an excellent colour rendering index and suit every application from the smallest theatre to the largest spectacular.

### Features

- **Multi-function double gate:** simultaneous use of gobos and iris. Sharp focus of both gobo and shutter
- **Shutter gate:** up to 8 shutters. Remove shutters for easy maintenance or tuck fully inside gate for secure transport
- **User-friendly shutter-lock system:** secures shutters' setting in any circumstances (locking efficient up to 4 shutters)
- **Universal gobo holder:** "A" size glass and metal gobo
- **90° rotating lens tube / gate / front accessories holder:** rotation of the projected image is always possible – no need to move the yoke
- **Internal glass filter holder:** long term use of durable coloured, dichroic or textured glass
- **Easy setup:** locally and remotely by RDM protocol - integrated display
- **DMX:** 8 or 16 bits dimming and strobe function
- **Parameters:** adjustable curves and response thru 4-button display with automatic light switch-off
- **Control:** local, DMX, wireless DMX (option)
- **Easy focus reference:** graduated scale on side of lantern; fast and easy refocusing
- **Tilt reference on hanging yoke:** index for rapid re-positioning

### Optical

- **Long life:** outstanding operational lifetime expectation, no need to replace lamps, low maintenance
- **SX optical system:** double condenser optics for exceptional optical quality
- **Coated double condenser optical system:** ensures optimal light transmission
- **Variable zoom optics:** sharp focus at every beam angle. Independent control of image size and focus. Focus handles on both sides
- **Electronic dimmer:** dimming without clipping or cut-out at low intensity levels; high quality smoothing
- **No colour shift:** colour temperature remains the same when dimming

### Construction

- **Made in France :** fully manufactured in Robert Juliat premises retaining complete control over all aspects of quality
- **PSU:** built-in electronic flicker-free power supply for easy, plug-and-play installation
- **Power connectors:** neutriK® powerCON TRUE1 IN and OUT connectors for daisy chaining
- **Silent-running cooling fans:** ideal for TV studios and opera houses
- **Electronic thermal management system:** ensures maximum performance of the system without any risk of overheating
- **Bodywork:** strong sheet metal construction for durability
- **Captive knobs and handles:** additional security when working at height or in transit
- **Spare parts and accessories:** uniform across the tungsten, discharge or LED range, reducing running costs
- **Easy access to all parts:** easy cleaning and maintenance

Picture:644SX

DSEN348\_644SX2\_WW - 11/09/2019

Robert Juliat reserves the right to change or alter any of the items detailed on this page, to increase or improve manufacturing techniques without prior notice.

Robert Juliat S.A.S., 32 rue de Beaumont, 60530 Fresnoy-en-Thelle - France  
Telephone : +33 (0)3 44 26 51 89 - fax : +33 (0)3 44 26 90 79 - info@robertjuliat.fr  
www.robertjuliat.com



ROBERT JULIAT

## Source

- **Lamp type:** LED
- **Power:** 150 W

LED specifications	Power *	Lumen output*	Colour temperature*	CRI* (min)
SUHD60/2 V3 WW (RJ / Osram )	150 W	14 190 lm	3000K	92

(\*) manufacturer's data

## Optics

### Characteristics

- **Type:** Zoom
- **Beam range:** 16° to 35°
- **Focal length:** 127 - 285 mm

### Gel filter

- **Shape:** Square
- **Standard size:** 180x180 mm (7.1x7.1 in)
- **Optional size:** 185x185 mm (7.3x7.3 in)

### Gobo

- **Size:** A
- **Material:** Metal  
Glass  
Plastic



100 mm

\*Maximum image size

## Photometrics

with source

## Remote control

- **Data protocol:** USITT DMX512-A  
RDM / Art-Net / sACN

- **Data IN connector:** 5 pins XLR male
- **Data OUT connector:** 5 pins XLR female



### • DMX chart:

#### Mode 1 (1 channels)

Dimmer

#### Mode 2 (4 channels)

Dimmer  
Dimmer fine  
-  
Strobe

#### Mode 3 (5 channels)

Dimmer  
Dimmer fine  
-  
Strobe  
Dimmer master

## Dimensions and weight

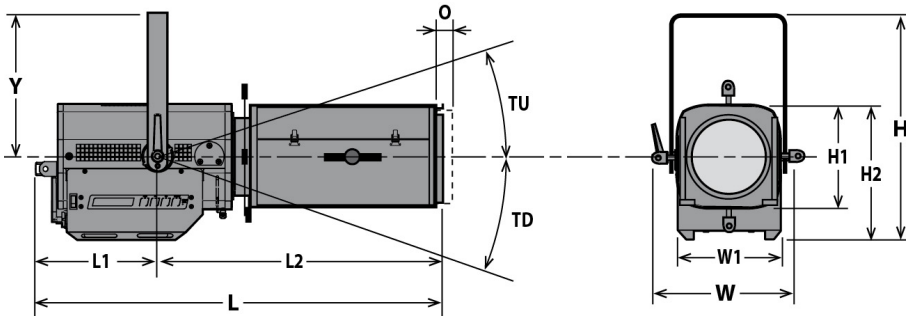

**Weight:** 17 kg (37.4 lbs)

Height	Length	Width	Yoke	Tilt	Option
H= 447 mm (17.6 in)	L= 810 mm (31.9 in)	W= 330 mm (13 in)	Y= 280 mm (11 in)	TU= 60°	O= 25 mm (1 in)
H1= 208 mm (8.2 in)	L1= 241 mm (9.5 in)	W1= 208 mm (8.2 in)		TD= 90°	
H2= 268 mm (10.6 in)	L2= 569 mm (22.4 in)				

## Shipping

- **Weight :** 20 kg (44 lbs)
- **Volume :** .16 m<sup>3</sup> (5.65 ft<sup>3</sup>)

## Installation

- **Minimum distance to illuminated surface:** 0.4 m ( 1.1 ft )
- **Operating position:**

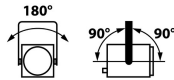

## Construction

- **Housing:** Steel sheet - Aluminium
- **Colour:** Black
- **Cooling:** Low noise variable fan
- **Maximum ambient temperature (Ta):** 40°C (104°F)
- **Maximum case temperature (Tc):** 65°C (149°F)
- **Total heat dissipation:** 631 BTU/h
- **Protection rating:** 20

## Electrical compatibility

- 220/230 V - 50 Hz
- 245 V - 50 Hz
- 110/120 V - 60 Hz
- 208 V - 60 Hz
- 220/230 V - 60 Hz
- 100 V - 50 Hz
- 100 V - 60 Hz
- Selector: automatic detection

## Power input



- **Type:** removeable power cord with Neutrik powerCON TRUE1 connector (included)
- **Cable:** H07RNF 3G1.5
- **Length:** 3 m (9,8 ft)
- **Power connector:** CEE 7/7 (2P+E NF/Schuko)

## Power consumption

Voltage	Frequency	Current	Power	Power factor
230 V	50 Hz	0.8 A	185 W	>0.95
120 V	60 Hz	1.5 A	185 W	>0.98
100 V	60 Hz	1.8 A	185 W	>0.98

## Power Supply Unit

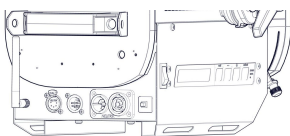

- **PSU:** Internal - Electronic PSU - Flicker free with PFC
- **Control:** Local / DMX
- **Protection:** Mains: 4A 1P1D breaker - UL /
- **Power thru:** Neutrik powerCON TRUE1 - Maximum of 19 units (230 V) / 10 units (120 V)

## Approvals



## Warranty

- **Period: 2 years**
- See General Sales Condition on website





## Acoustics

- **Noise level:** < 22,7 dB(A)













## Model

<b>644SX2 WW</b>	LED 150 W Profile spot - 644SX2 WW ZEP2 - Warm White - 16/35°
------------------	---

## Options

<b>CAV600</b>	Double slot front cassette for 180x180mm accessories	
<b>CAV600E</b>	Double slot front cassette for 185x185mm accessories	
<b>PCP1716A</b>	16A blue 2P+E 6h IEC60309 power connector	
<b>W-DMX/Z</b>	W-DMX wireless DMX	

## Accessories

<b>D8</b>	Shutter for SX series <b>4 included</b>	
<b>PF500M2</b>	180x180mm metal filter holder <b>1 included</b>	
<b>SGUX</b>	Universal "A" size gobo-holder (metal, glass, frosted glass) <b>1 included</b>	
<b>IWSX755</b>	Drop-in iris (monoplane) with holder - Weight: ,26 Kg	
<b>PF600M2</b>	185x185mm metal filter holder	
<b>G500</b>	180x180mm safety grid	
<b>CAV600A</b>	Double slot front cassette for 180x180mm accessories - Weight: ,43 Kg	
<b>CAV600AE</b>	Double slot front cassette for 185x185mm accessories - Weight: ,45 Kg	
<b>VD120</b>	120x120mm frosted glass	
<b>FCD600</b>	Angled yoke	
<b>876</b>	Hook clamp 40x10mm with 28mm M10 screw for Ø35 to 50mm pipes - SWL: 50Kg - Weight: 1,25 Kg	
<b>880</b>	Hook clamp 40x10mm with 28mm M10 screw for Ø50 to 63mm pipes - SWL: 50Kg - Weight: 1,36 Kg	

**CS2**

Safety cable Ø3 mm L= 600mm - SWL: 75 Kg

