

QUINCY - 424SX

4205X - 575 W MSD



- **Type:** Profile spot
- **Source:** 575 W MSD
- **PSU:** Electronic - hot restrike
- **Optics:** 16° to 35° zoom

Profile spot

For crisp, punchy gobo projection

Quincy is a bright discharge light source, ideal for projecting logos and images at corporate events or for architectural enhancement. Its crisp optics provide the perfect solution for projecting static images without complex moving lights and DMX controllers.

Features

- **Multi-function double gate:** simultaneous use of gobos and iris. Sharp focus of both gobo and shutter
- **Shutter gate:** up to 8 shutters. Remove shutters for easy maintenance or tuck fully inside gate for secure transport
- **User-friendly shutter-lock system:** secures shutters' setting in any circumstances (locking efficient up to 4 shutters)
- **Universal gobo holder:** a-size glass and metal gobo
- **Lens tube lock feature:** secures rotating lens tube against unwanted movement
- **90° rotating lens tube / gate / front accessories holder:** rotation of the projected image is always possible while the lamp remains vertical – no need to move the yoke
- **Internal glass filter holder:** long term use of durable coloured, dichroic or textured glass
- **Easy focus reference:** graduated scale on side of lantern; fast and easy refocusing
- **Tilt reference on hanging yoke:** index for rapid re-positioning

Optical

- **Long lamp life (2000 h)**
- **Factory set optical train:** no re-alignment even after lamp change
- **SX optical system:** double condenser optics for exceptional optical quality
- **Gobo :** excellent gobo projection
- **Variable zoom optics:** sharp focus at every beam angle. Independent control of image size and focus. Focus handles on both sides

Construction

- **Made in France :** fully manufactured in Robert Juliat premises retaining complete control over all aspects of quality
- **Interchangeable lamp bases with 600 SX (1000/1200 W tungsten) series**
- **Bodywork:** strong sheet metal construction for durability
- **Moving parts:** smooth at all times, even when hot
- **Captive knobs and handles:** additional security when working at height or in transit
- **Easy access to all parts:** easy cleaning, re-lamping and maintenance
- **Removable assemblies:** fast-plug cable connectors and complete component assemblies (mirror, condenser set and lamp house assembly) save maintenance and cleaning time
- **Spare parts and accessories:** uniform across the tungsten, discharge or LED range, reducing running costs

Picture:424SX

DSEN038_424SX - 16/06/2017

Robert Juliat reserves the right to change or alter any of the items detailed on this page, to increase or improve manufacturing techniques without prior notice.

Robert Juliat S.A.S., 32 rue de Beaumont, 60530 Fresnoy-en-Thelle - France
Telephone : +33 (0)3 44 26 51 89 - fax : +33 (0)3 44 26 90 79 - info@robertjuliat.fr
www.robertjuliat.com



ROBERT JULIAT

Source



- **Lamp type:** Discharge
- **Power:** 575 W
- **Socket:** G22
- **Hot re-strike:** yes

Admissible lamps	Power *	Lumen output*	Colour temperature*	Life*	CRI* (min)
MSD 575W HR (Philips)	575 W	46 000 lm	6000K	2 000 h	75

(*) manufacturer's data

Optics

Characteristics

- **Type:** Zoom
- **Beam range:** 16° to 35°
- **Focal length:** 127 - 285 mm

Gel filter

- **Shape:** Square
- **Standard size:** 180x180 mm (7.1x7.1 in)
- **Optional size:** 185x185 mm (7.3x7.3 in)

Gobo

- **Size:** A
- **Material:** Metal
Glass



Photometrics

with MSD 575W HR (Philips) source

• Optics @ 16°

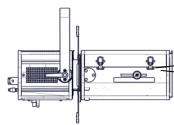

16°

Field angle
3%

Beam intensity
243 000 cd

Distance	10 m	15 m	20 m	25 m	30 m	35 m
Diameter	2.8 m	4.2 m	5.6 m	7 m	8.4 m	9.8 m
Illumination	2 450 lux	1 100 lux	610 lux	390 lux	280 lux	200 lux
Distance	35 ft	50 ft	65 ft	80 ft	100 ft	115 ft
Diameter	9.8 ft	14.1 ft	18.3 ft	22.5 ft	28.1 ft	32.3 ft
Illumination	200 fc	100 fc	60 fc	38 fc	25 fc	19 fc

• Optics @ 35°

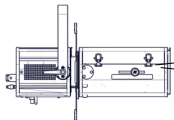

35°

Field angle
3%

Beam intensity
63 000 cd

Distance	10 m	15 m	20 m	25 m	30 m	35 m
Diameter	6.3 m	9.5 m	12.6 m	15.8 m	18.9 m	22.1 m
Illumination	640 lux	290 lux	160 lux	110 lux	75 lux	55 lux
Distance	35 ft	50 ft	65 ft	80 ft	100 ft	115 ft
Diameter	22.1 ft	31.5 ft	41 ft	50.4 ft	63.1 ft	72.5 ft
Illumination	55 fc	26 fc	15 fc	10 fc	7 fc	5 fc

Dimensions and weight

Unit

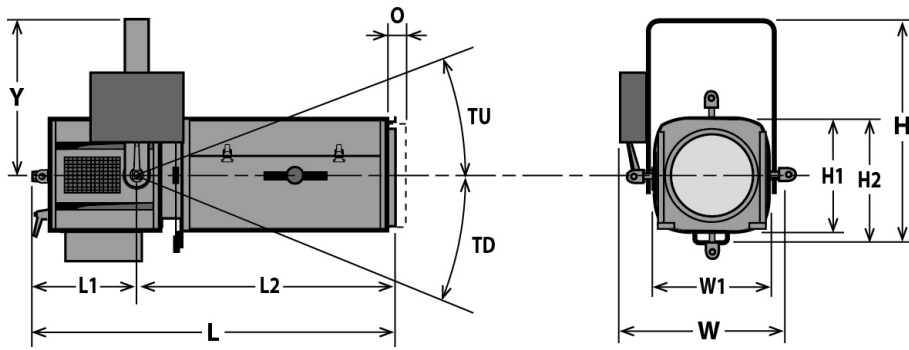

Weight: 15.5 kg (34.1 lbs)
with PSU

Height	Length	Width	Yoke	Tilt	Option
H= 440 mm (17.3 in)	L= 695 mm (27.4 in)	W= 330 mm (13 in)	Y= 280 mm (11 in)	TU= TBD°	O= 25 mm (1 in)
H1= 208 mm (8.2 in)	L1= 250 mm (9.8 in)	W1= 208 mm (8.2 in)		TD= TBD°	
H2= 270 mm (10.6 in)	L2= TBD mm (0 in)				

Shipping

PSU

• **Weight:** 17.8 kg (39.2 lbs)

Width: W= 71 mm (2.8 in)

• **Volume:** .09 m³ (3.18 ft³)

Height: H= 162 mm (6.4 in)

Length: L= 245 mm (9.6 in)

Weight: 2.8 Kg (6.2 lbs)

Installation

• **Minimum distance to illuminated surface:** 2.0 m (6.6 ft)

• **Operating position:**

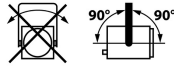

Warranty

• **Period:** 2 years

See General Sales Condition on website

Approvals



Construction

- **Housing:** Steel sheet - Aluminium
- **Colour:** Black
- **Cooling:** Convection cooling
- **Maximum ambient temperature (Ta):** 40°C (104°F)
- **Maximum case temperature (Tc):** 260°C (500°F)
- **Total heat dissipation:** 2 458 BTU/h
- **Protection rating:** 20

- **PSU housing:** Steel sheet - Aluminium
- **PSU colour:** Black
- **PSU cooling:** Fan
- **PSU maximum ambient temperature (Ta):** 40°C (104°F)
- **PSU maximum case temperature (Tc):** 65°C (149°F)

Electrical compatibility

- 220/230 V - 50 Hz
- 245 V - 50 Hz
- 110/120 V - 60 Hz
- 208 V - 60 Hz
- 220 V - 60 Hz
- 100 V - 50 Hz
- 100 V - 60 Hz
- Selector: automatic detection

Power input



- **Type:** attached power cord
- **Cable:** H07RNF 3G1.5
- **Length:** 3 m (9,8 ft)
- **Power connector:** CEE 7/7 (2P+E NF/Schuko)

Power consumption

Voltage	Frequency	Current	Power	Power factor
230 V	50 Hz		720 W	TBD
120 V	60 Hz		720 W	TBD
90 V	50 Hz		720 W	TBD

Power Supply Unit

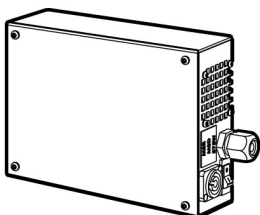



- **PSU:** On yoke - Electronic PSU - Flicker free with PFC
- **Lighting unit / PSU cable:** Cable attached to unit - length: 1,5 m (4,9 ft)
Type: 3G1,5 H07RNF with Neutrik PowerCon® (ref. NAC3FCB) connector
- **Maximum distance between lighting unit and PSU:** 25 m (82 ft)
- **Control:** Local
- **Protection:** Mains: 10A 5x20 time-delay fuse /













Model



424SX	575 W MSD Profile spot - 424SX Quincy - 16/35° - Electronic PSU
--------------	---

Options

LT-Profile	Licht-Technik motorisation controlled by DMX: Pan, tilt, zoom, focus, 4 shutters, colour changer	
CAV600	Double slot front cassette for 180x180mm accessories	
CAV600E	Double slot front cassette for 185x185mm accessories	
PCP1716A	16A blue 2P+E 6h IEC60309 power connector	

Accessories

D8	Shutter for SX series 4 included	
PF500M2	180x180mm metal filter holder 1 included	
SGUX	Universal "A" size gobo-holder (metal, glass, frosted glass) 1 included	
MSD 575W HR	MSD 575W HR - Philips G22 575W 2000h 6000K lamp	
IWSX755	Drop-in iris (monoplane) with holder - Weight: ,26 Kg	
G500	180x180mm safety grid	
CAV600A	Double slot front cassette for 180x180mm accessories - Weight: ,43 Kg	
CAV600AE	Double slot front cassette for 185x185mm accessories - Weight: ,45 Kg	
T/600SX	Lamp compartment for 1000/1200W tungsten GX9,5 lamps - 3 meter power cable with CEE 7/7 (2P+T NF/SCHUKO) connector - Weight: 1,36 Kg	
T/600VSX	Lamp compartment for 1000/1200W tungsten G22 lamps with fan - 3 meter power cable with CEE 7/7 (2P+T NF/SCHUKO) connector - Weight: 2,03 Kg	
VD120	120x120mm frosted glass	
FCD600	Angled yoke	

876	Hook clamp 40x10mm with 28mm M10 screw for Ø35 to 50mm pipes - SWL: 50Kg - Weight: 1,25 Kg	
880	Hook clamp 40x10mm with 28mm M10 screw for Ø50 to 63mm pipes - SWL: 50Kg - Weight: 1,36 Kg	
CS2	Safety cable Ø3 mm L= 600mm - SWL: 75 Kg	