

Lupo
Made in Italy

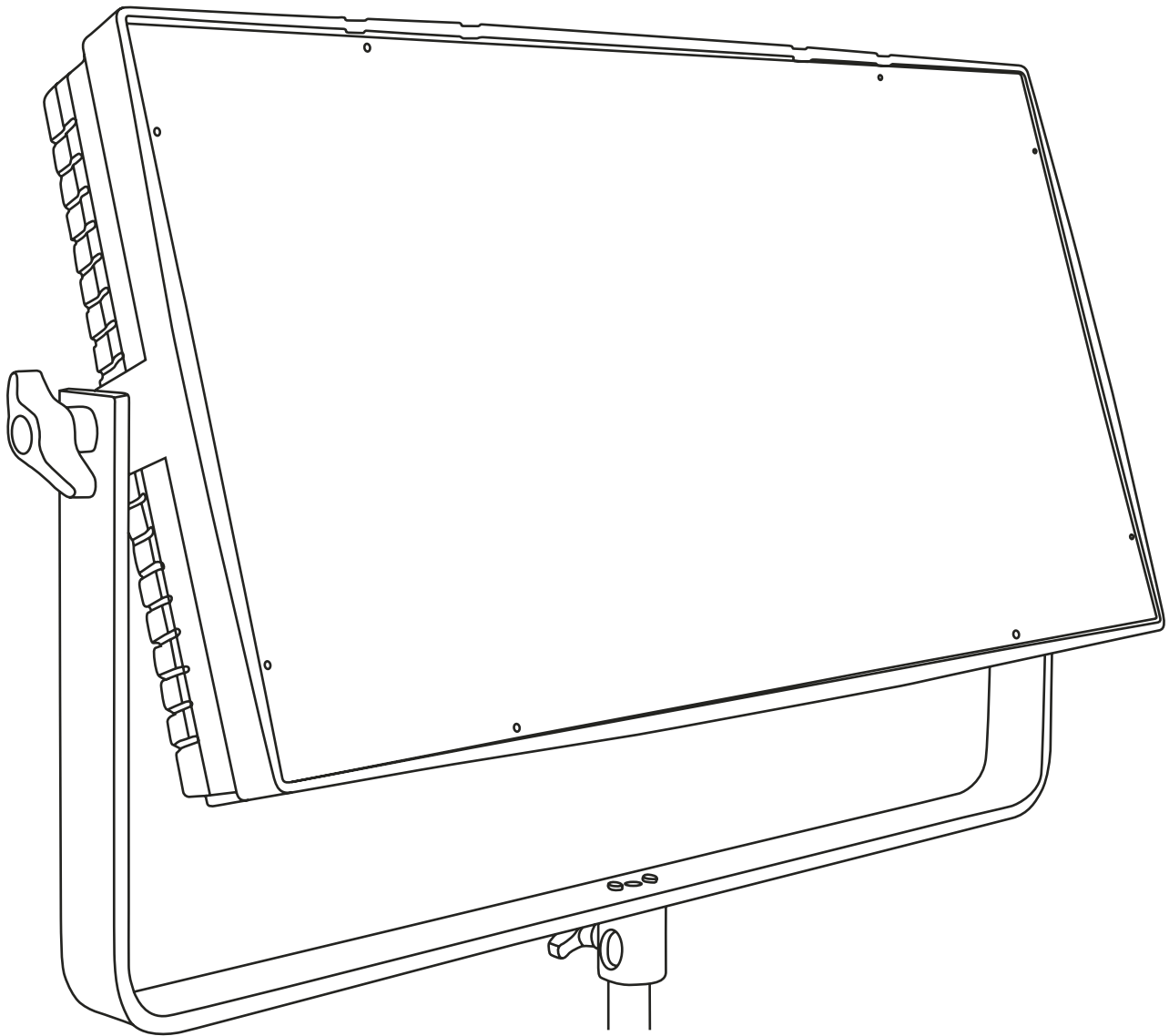

Cod 814

Ultrapanel Dual Color 60 Soft

Technical Data

Dimensions (cm)	673 x 340 x 113 mm
Dimensions (in)	26.4 x 13.5 x 4.4 in
Weight (kg)	9 kg
Weight (lb)	19.8 lb
CRI (Colour Rendering Index)	95
TLCI (Television Lighting Consistency Index)	96
Estimated LED lifetime (L80)	50,000 hours
Dimmer 0 - 100	included
Dimming curves mode	Linear, Exponential, Logarithmic
DMX module	included
DMX (bit)	8 bit / 16 bit
Connection for 14.8 V battery with standard XLR 4 pin connector (pin 1: negative / pin 4: positive)	included
Standard XLR 5 pin connectors to DMX console	included
Watt consumption	400 W
Watt output (equivalent to tungsten)	8000 W
Firmware upgrades	through USB port
Colour temperature	2800 K - 6500 K
Voltage AC	90 V - 240 V
Voltage DC	14.8 V
Light beam	120°
Frequency (input)	50 / 60 Hz
Compliance	CE
Remote control	Bluetooth Long Range / DMX / RDM
Ambient temperature	Max: + 45°C / Min: - 10°C
Power factor	0.9

Photometric data	6500 K	5600 K	3200 K
Distance			
Lux at 1 m - 3.2 ft	17300	16600	15100
Lux at 2 m - 6.5 ft	4400	4280	4050
Lux at 3 m - 9.8 ft	2150	2080	1950
Lux at 4 m - 13.1 ft	1320	1290	1180
Lux at 5 m - 16.4 ft	850	840	800

Technical Drawing

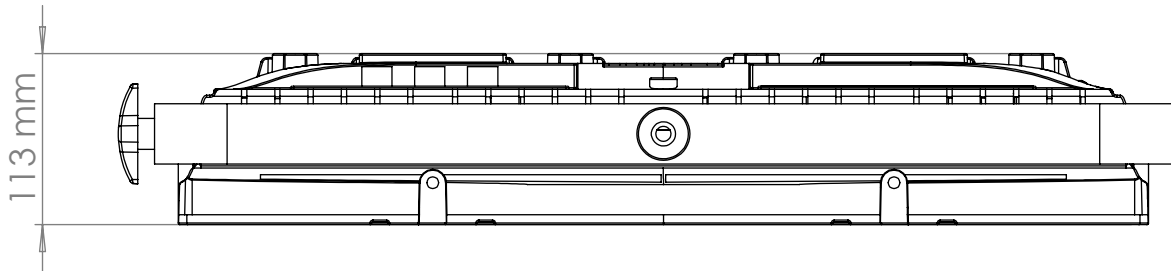
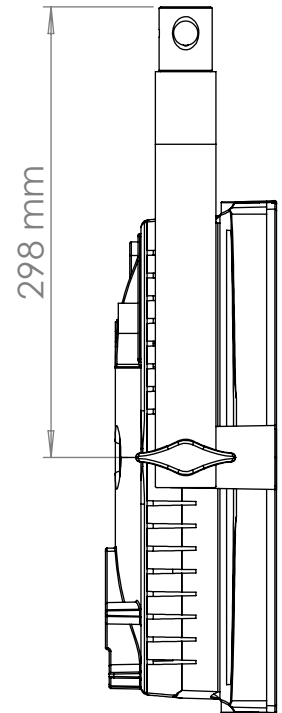
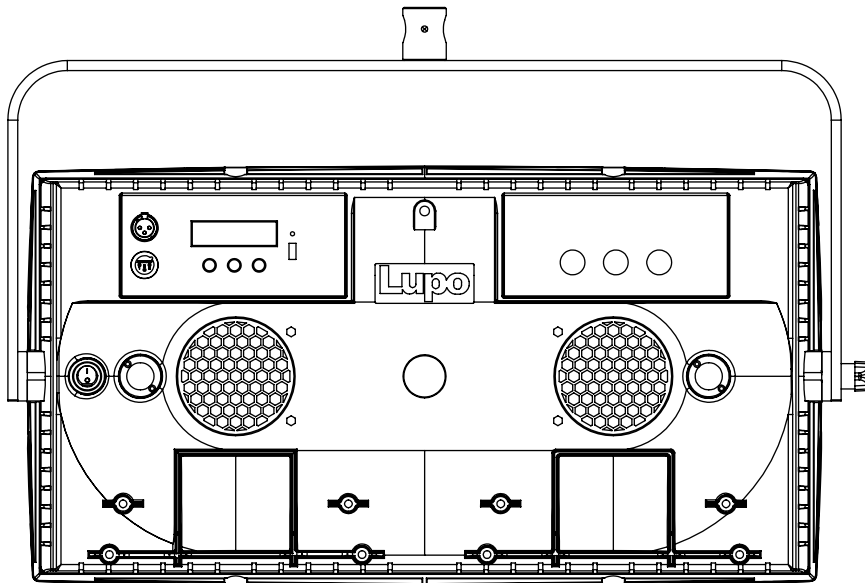
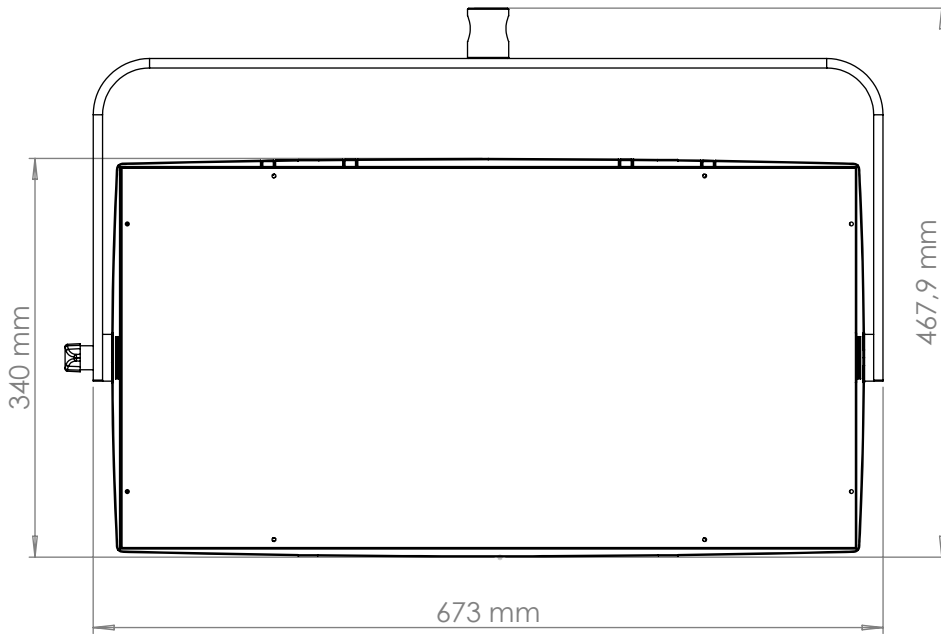

Lupo

Made in Italy

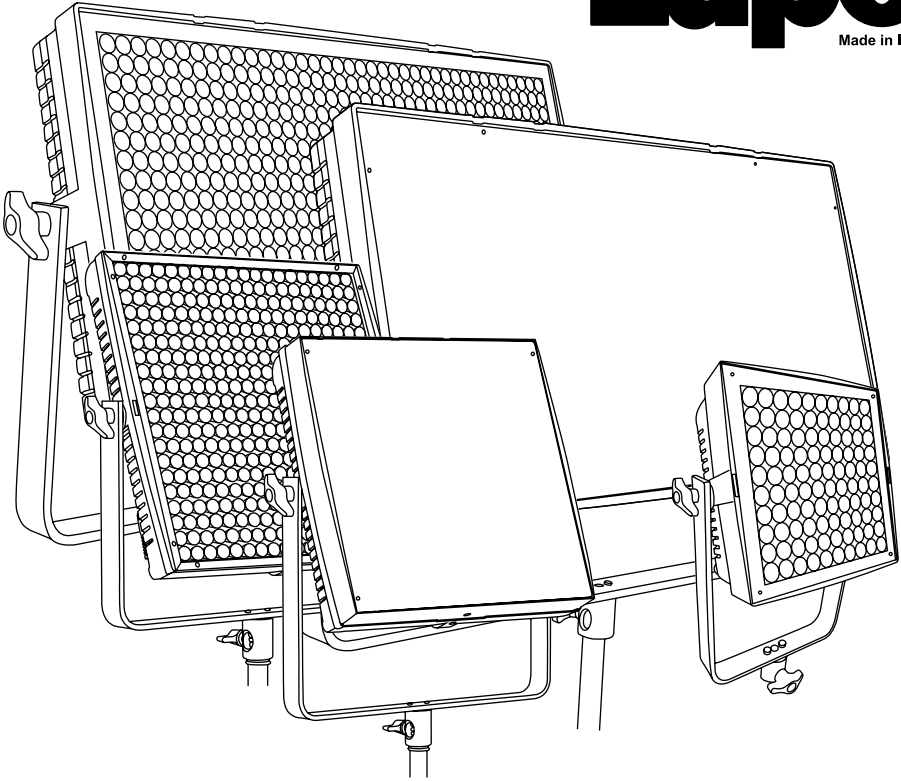

User Manuals

Superpanel 30 Dual Color

Superpanel 60 Dual Color

Actionpanel Dual Color

Ultrapanel 30 Dual Color

Ultrapanel 60 Dual Color

Release 7.xx

SAFETY PRECAUTIONS:

Do not operate the equipment before studying the instruction manual and the accompanying safety precautions. Make sure that Lupo Safety Instruction is always included with the equipment! Lupo products are intended for professional use. Do not place or use the equipment where it can be exposed to moisture, extreme electromagnetic fields or in areas with flammable gases or dust! Do not expose the equipment to hasty temperature changes in humid condition as could lead to condensation water in the unit. Equipment must only be serviced, modified or repaired by authorized. Dealers or the factory.

CAUTION - BURN HAZARD - HOT PARTS

Do not touch hot parts with bare fingers! LED bulbs and certain metal parts emit strong heat when used!
Do not point lamps too close to persons.
Always use the fixtures with the front part closed.

NOTICE - EQUIPMENT OVERHEATING RISK

Do not obstruct ventilation by placing filters, diffusing materials, etc. over inlets and outlets of the equipment ventilation or directly over glass cover or LED bulbs.

FINAL DISPOSAL

Equipment contains electrical and electronic components that could be harmful to the environment.
Equipment may be returned to Lupo distributors free of charge for recycling according to WEEE.

Follow local legal requirements for separate disposal of waste, for instance WEEE directive for electrical and electronic equipment on the European market, when product life has ended.

MAINTENANCE AND CARE

Please do not forget that the safe operation of lampheads also includes their maintenance and care.

A visual inspection should be conducted before every use and an inspection of electrical safety should be conducted at least once every 12 months.

WARRANTY

The warranty period for Lupo products and those marketed by Lupo is twelve months from the date of delivery. Lupo guarantees that the goods it supplies are well manufactured and of good quality. The warranty guarantees the repair of any parts that show acknowledged defects in materials, construction or workmanship during the warranty period. The guarantee excludes any liability for direct or indirect damage of any kind and for any reason, for which Lupo will therefore not be required to pay compensation. The customers shall see to deliver the parts that need repair or replacement to Lupo's works at their own expense and risk. The repaired or replacement parts shall be delivered by Lupo ex-works. The customers will be charged for materials and labor or replacement of the product after the expiration of the warranty period.

⚠ WARNING:

When hanging the fixture from higher position, please make sure you use safety cable to attach the barndoors to the yoke of the panel.

Barndoors should always be used to secure the fixture and the application when used in this way.

Another safety cable should be used to secure the fixture to the mounting pipe or truss.

Both safety cables must be properly dimensioned for the fixture and the application when the fixture is operated in hanging position please ensure that the accessories are installed correctly with top latch locked.

*Thanks for having purchased **Lupo** products. All the products are made in Italy and all the efforts have been put to keep the quality standards high. We hope this product can help you in your job and make your life easier as a professional. We also hope you will enjoy its use and we would be happy to receive your feedback about it.*

Instructions

- Device for indoor use only.
- Maximum ambient temperature: 40 °C.
- Make sure power supply plug is suitable to power required.
- As prescribed by international regulations, a safety cable must be used when the fixture is suspended from ceiling.
- To switch on the light push the on/off button.
- Superpanel models are equipped with new generation high quality powerleds.

Getting Started with the Actionpanel

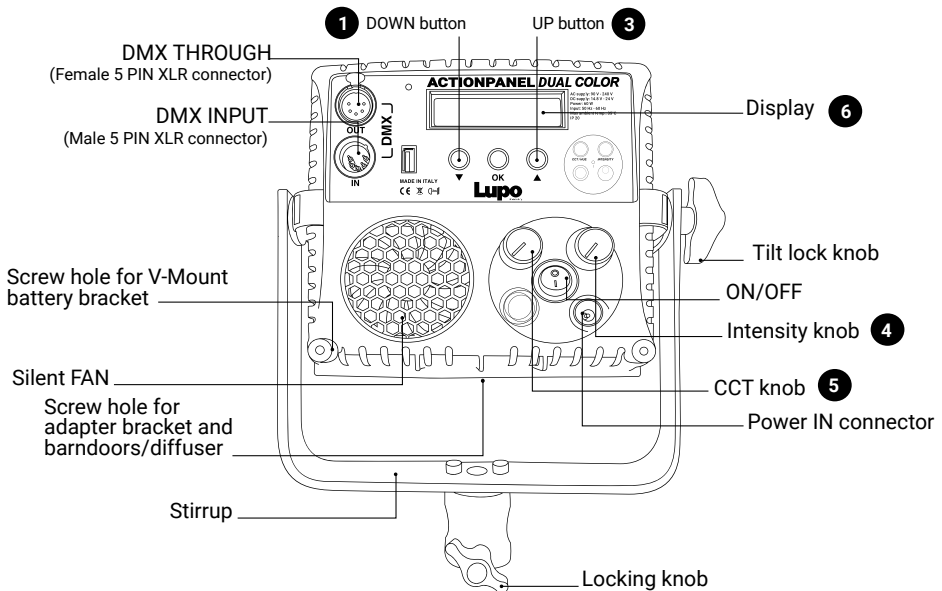

Turning on the Actionpanel

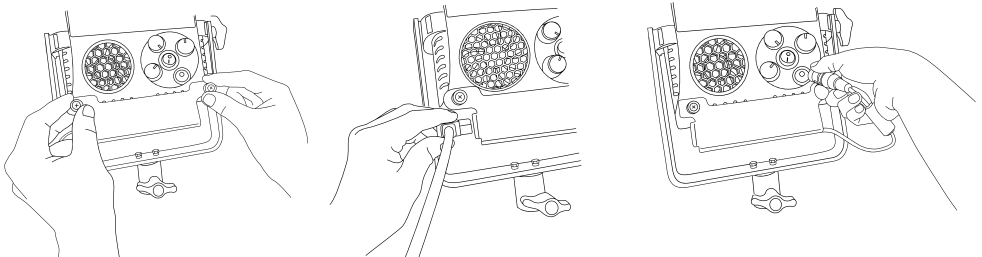

1 Place the AC Adapter in the mounting bracket via the 2 captive screws to the bottom of the ACTIONPANEL fixture.

2 Insert the power cord cable into the AC adapter and connect the fixture to the power plug.

3 Insert the DC connector into the input jack on the ACTIONPANEL and **power on** the fixture.

Getting Started with the Superpanel 30 and the Ultrapanel 30

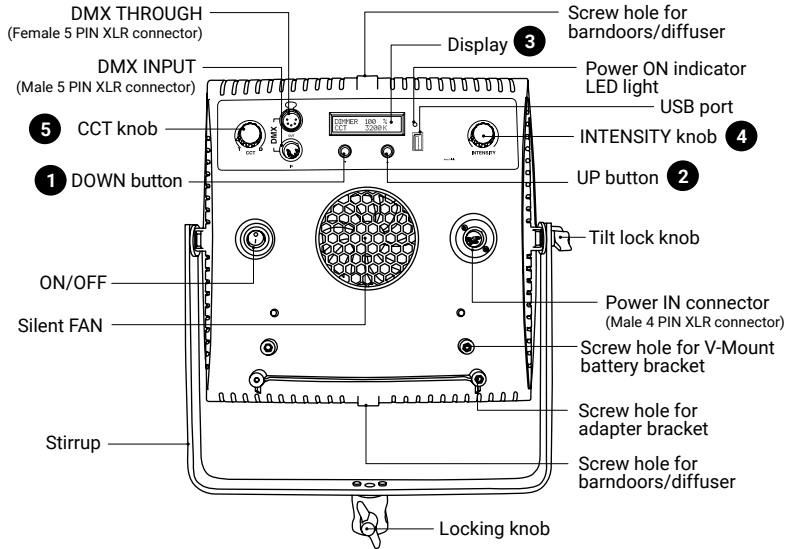

Turning on the Superpanel 30 and the Ultrapanel 30

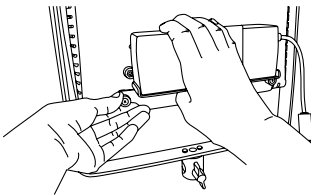

- 1 Place the AC Adapter in the mounting bracket via the 2 captive screws to the bottom of the SUPERPANEL 30 fixture.

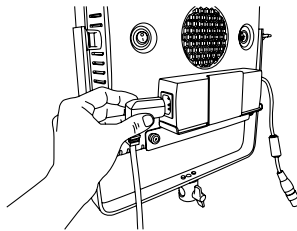

- 2 Insert the power cord cable into the AC adapter and connect the fixture to the power plug.

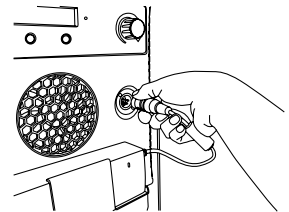

- 3 Insert the DC XLR 4 pin connector into the input jack on the SUPERPANEL 30 and **power on** the fixture.

Getting Started with the Superpanel 60 and the Ultrapanel 60

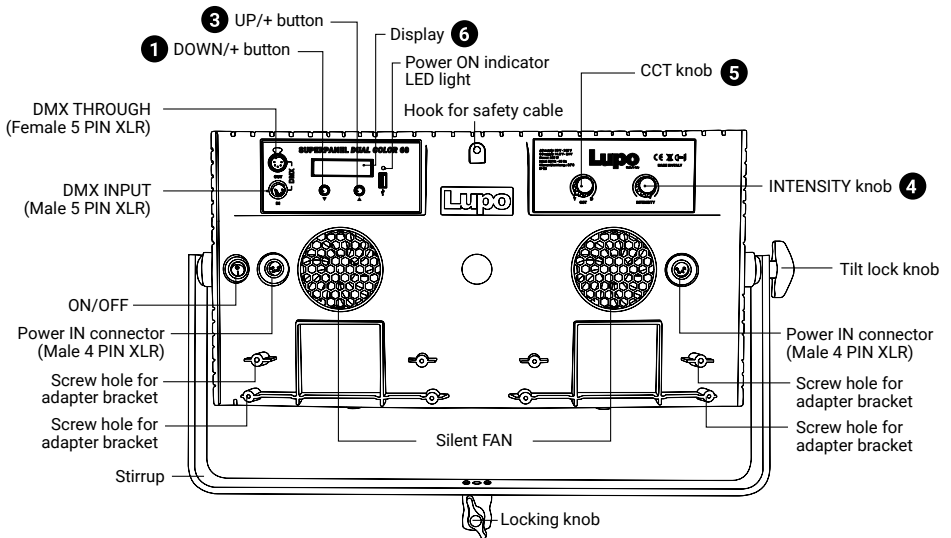

Turning on the Superpanel 60 and the Ultrapanel 60

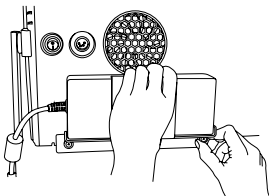

1 Place the two AC Adapters in the mounting brackets via the 2 captive screws of the SUPERPANEL 60 fixture.

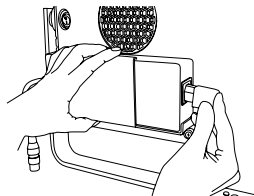

2 Insert the two power cord cables into the AC adapters and connect the fixture to the power plug.

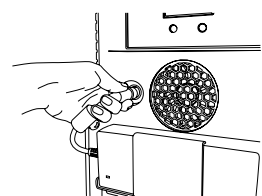

3 Insert the two DC XLR 4 pin connectors into the input jacks on the SUPERPANEL 60 and **power on** the fixture.

CONTROL PANEL

- In current mode press the **5** push button to enter the main MENU.
- In the sub-menus press the **5** push button to confirm a selection.
- Rotate the **5** knob to navigate in the main MENU and sub-menus.
- Use the « **INTENSITY** » **4** knob to adjust the **light intensity from 0 to 100%**.
- Use the knobs **5** and **4** to adjust the light mode parameters.
- Display **3**.

⚠ ATTENTION: The **light intensity** level is adjustable from **0 - 50%** if the **FAN** is **OFF**. The value on the display flashes.

MANUAL OPERATION

1. Press the **5** push button to enter the main MENU.
2. Select **MANUAL** by pressing the **5** push button.
3. Select the light mode between **CCT / EFFECT** with the **5** knob and press the **5** push button to confirm selection.
4. See **LIGHT MODES**.

LIGHT MODES

MODE	INTENSITY 4	CCT/HUE 5	GN/SAT/COLOR 6	« ▾ » 1 « ▸ » 3
CCT	Light Intensity from 0 to 100%	CT 2800K to 6500K	GN -1.00 to +1.00	-
EFFECT		"See EFFECT table"	"See EFFECT table"	Change Effect

In **CCT Mode**, the « ▸ » **1** key selects the **STROBE** page and the « ▾ » **2** key exits the **STROBE PAGE**.

In the **STROBE PAGE** it is possible to set **DIMMER** value and the **STROBE** frequency by rotating the **5** button.

ATTENTION: **STROBE** frequency = 0 means **STROBE** effect **OFF**.

- A. CCT MODE:** Warm and cold white control mode. It allows you to adjust colour temperature (CCT), green/magenta compensation (GN) and light intensity. *This is the default setting.*
- B. SPECIAL EFFECT MODE:** Mode with 3 SPECIAL EFFECTS. **TELEVISION BW / PAPARAZZI / LIGHTNING**

1. In **MANUAL OPTIONS** or **DMX MODE** menu select **EFFECT MODE**.
2. Select the **EFFECT** to be activated with rotate the **5** button, confirm the selection by pressing the **5** push button.
3. In current mode, use the « ▾ » **1** or « ▸ » **2** button to change the **EFFECT** in ascending or descending order. **THE EFFECT ON THE DISPLAY IS THE SELECTED EFFECT.**
4. Use the knobs **5** and **4** to adjust the effect setting values. **See table below.**

EFFECT	4 INTENSITY knob	5 CCT/HUE knob	6 GN/SAT/COLOR knob
TELEVISION BW	Light Intensity from 0 to 100%	White range - 1 / 2 / 3 / 4	Frequency - 4 to 24 Hz
PAPARAZZI		Flashing Interval - 1 to 10	Bulb type - 0 / 1 / 2
LIGHTNING		Color Temperature	Lightnings Interval - 1 to 20

DMX OPERATION

1. Press the **5** push button to enter the main MENU.
2. Select **DMX** with the **5** knob and press the **5** push button to confirm selection.

3. Select the light mode between **CCT / EFFECT** with the **5** knob and press the **5** push button to confirm selection.
4. Select the DMX channel, rotating the **5** knob to change DMX ADDRESS in ascending or descending order between 1 and 512. The number shown on the display **3** is the selected channel to communicate with the control desk.
5. See **DMX PROTOCOL MANUAL** to DMX channel specification.

NOTE: The symbol - ! - on the display indicates that there is **no DMX signal**.

BLUETOOTH

Enable / Disable BLE App interface

DMX OPERATION - Advanced Settings

1. Press the **5** push button to enter the main MENU.
2. Navigate through the main MENU with the **5** knob and press the **5** push button to confirm selection.
3. Rotate the **5** knob to select **DMX ADVANCED**, press the **5** push button to confirm selection.
4. Select one of the options among the **DMX BIT**, **DMX SIGNAL LOSS**, **RDM ENABLE** and **STROBE ENABLE** press **5** push button to confirm the selection.

DMX BIT:

Resolution of the DMX control. 8bit 1 channel per function and 16 bit 2 channels per function.

1. Select the **DMX BIT** item by pressing the **5** push button.
2. Rotate the **5** knob to choose between **8bit / 16bit**, press the **5** push button to confirm the selected setting. See **DMX PROTOCOL MANUAL**.

DMX SIGNAL LOSS:

This feature allows to choose the device's behaviour in case of a DMX signal loss.

1. Select the **LOSS DMX SIGNAL** item with the **5** push button
2. Rotate the **5** knob to select the device's behaviour between **BLACK OUT /SETTINGS LAST / SETTINGS 1min**, press the **5** push button to confirm the setting.

Black out: The device switches off.

Settings Last: The values of the last selected setting are maintained over time until the device is switched off.

Settings 1min: The values of the last selected settings is maintained for one minute and then the device switch off.

RDM Enable: ON/OFF, enable/disable RDM Protocol

INV CCT: ON/FF: enable/disable reversal CCT console control

RDM

Protocol Specification

COMMAND	PID	DESCRIPTION
Manufacturer ID	0x0622	Manufacturer identification number (LUPO Lighting).
Device Identification		
Model ID		Model identification number
	0x0001	Dayled 650 mono color
	0x0002	Dayled 650 dual color
	0x0003	Dayled 1000 mono color
	0x0004	Dayled 1000 dual color
	0x0005	Dayled 2000 mono color
	0x0006	Dayled 2000 dual color
	0x0007	Superpanel 30 dual color soft
	0x0008	Superpanel 30 dual color lens
	0x0009	Superpanel 30 full color soft
	0x0010	Superpanel 30 full color lens
	0x0011	Superpanel 60 dual color soft
	0x0012	Superpanel 60 dual color lens
	0x0013	Superpanel 60 full color soft
	0x0014	Superpanel 60 full color lens
	0x0015	Actionpanel dual color soft
	0x0016	Actionpanel dual color lens
	0x0017	Actionpanel full color soft
	0x0018	Actionpanel full color lens
	0x0019	Kickasspanel dual color
	0x0020	Kickasspanel full color
	0x0021	Lupoled monocolor
	0x0022	Lupoled dualcolor
	0x0023	Movielight monocolor
	0x0024	Movielight dual color
	0x0025	Ultrapanel 30 dual color soft
	0x0026	Ultrapanel 30 dual color lens
	0x0027	Ultrapanel 60 dual color soft
	0x0028	Ultrapanel 60 dual color lens
	0x0029	Ultrapanel 30 full color soft
	0x0030	Ultrapanel 30 full color lens
	0x0031	Ultrapanel 60 full color soft
	0x0032	Ultrapanel 60 full color lens
Personality		DMX Personality
	0x01	CCT
	0x0A	TELEVISION BW

	0x0C	PAPARAZZI
	0x0D	LIGHTNING
Network management		
DISC UNIQUE BRANCH	0x0001	Search RDM devices
DISC MUTE	0x0002	Mute RDM device, no response message
DISC UN MUTE	0x0003	Activate RDM device fo response message
Status collection		
QUEUED MESSAGES	0x0020	Retrieves queued messages or status message if no message is in queue
STATUS MESSAGES	0x0030	Retrieves current Warning/Error messages
RDM Information		
SUPPORTED PARAMETERS	0x0050	Retrieves a list of all supported RDM commands
PARAMETER DESCRIPTION	0x0051	Retrieves a list of all RDM commands
Product Information		
DEVICE INFO	0x0060	Retrieves a variety of information about the device that is normally required by a controller.
DEVICE MODEL DESCRIPTION	0x0080	Text description of up to 32 characters for the device model type.
MANUFACTURER LABEL	0x0081	This parameter provides an ASCII text response with the Manufacturer name for the device. "LUP0" is the default name.
FACTORY DEFAULTS	0x0090	Set the device to its factory defaults. Get: Check if settings still in default state -> 1 if default
SOFTWARE VERSION LABEL	0x00C0	Retrieves software version string of main software
DMX512 Setup		
DMX PERSONALITY	0x00E0	DMX mode
DMX PERSONALITY DESCRIPTION	0x00E1	Shows a description of a DMX-Mode, max 32 characters
DMX START ADDRESS	0x00F0	DMX address
Control		
IDENTIFY DEVICE	0x1000	The identify flag (flashes the light)
Manufacturer Commands		
FAN MODE	0x8001	0: Off 1: On
DISPLAY TIMEOUT	0x8002	0: 30 sec 1: 1 min 2: always on
DMX SIGNAL LOST MODE	0x8003	0: black out 1: last settings on 2: last settings 1 min
DMX BITS	0x8004	0: 8 bit 1: 16 bit
CCT LIMIT	0x8005	0: 2800-10000 1: 3200-5600
LINEARIZATION	0x8006	0: linear 1: exponential 2: logarithmic
FILTER	0x8007	0: full speed 1: normal speed 2: high speed 3: low speed
FREQUENCY	0x8008	0: 18 KHz 1: 25 KHz
INV - CCT	0x8009	0: not inverted 1: inverted

DEVICE SETTINGS

1. Press the **5** push button to enter the main MENU.
2. Navigate through the MENU rotating the **5** button, select **DEVICE SETTINGS**, press the **5** push button to confirm the selection.
3. Navigate through the **FAN / DISPLAY / MENU VIEW / FREQUENCY / FILTER / LINEARIZATION** functions, rotating the **5** button to select the desired function and press the **5** push button to confirm the selection.
4. Within each function select the option to be activated and rotate the **5** button.

Fan: Fan operation. **ON / OFF.**

When the fan is **OFF** the **light intensity** be adjustable between **0 and 50%**.

Display: Time during which the display backlight stays on. **30sec / 1min / ALWAYS ON.**

Menu View: Type the main MENU, sub-menus and functions to show. **ONLY MANUAL / ONLY DMX / MANUAL/DMX.**

Frequency: Dimmer frequency 18 KHz - 25 KHz

Filter: It is the speed response of the system (smooth factor).

FULL SPEED / NORMAL SPEED / HIGH SPEED / LOW SPEED.

Linearization: Linearization is the compensation curve for the human eye's perception of the luminous intensity emitted as a function of the required power. Required power = dimmer value on the display. **LINEAR / EXPONENTIAL / LOGARITHMIC.**

Linear: No compensation, the intensity of the light is directly proportional to requested power.

Exponential: The light intensity increases from 0 to 100 exponentially.

Logarithmic: The light intensity increases from 0 to 100 logarithmically.

CCT Limit: CCT range 2800 - 6500 or 3200 - 5600

RESET DEVICE

1. Press the « **OK** » **2** button to enter the main MENU.
2. Select **RESET DEVICE** rotating the **5** button, press the **5** push button to confirm the selection.
3. Select **YES** rotating the **5** button, press the **5** push button to confirm the selection.
4. The device ask for further confirmation, select **YES** by pressing the press the **5** push button. **THE DEVICE RETURN TO FACTORY DEFAULT SETTINGS.**

FACTORY DEFAULT SETTING

MANUAL OPERATION

MODE: CCT

DMX OPERATION

MODE: CCT

BIT: 8 BIT

DMX SIGNAL LOSS: Settings 1 MIN

RDM ENABLE: OFF

INV - CCT: OFF

DEVICE SETTINGS

FAN: ON

DISPLAY: 1 min

MENU VIEW : Manual/DMX

FILTER : Normal speed

LINEARIZATION: Linear

FREQUENCY: 18 KHz

BLUETOOTH

Bluetooth Active: OFF

DMX OPERATION - DMX protocol

The Actionpanel can be used with **8 bit** (1 channel per function) and **16 bit** (2 channels per function). The Actionpanel uses consecutive channels starting from the DMX address set on the panel used as reference for the connection to the control desk. Please take the above into consideration when using many units of Actionpanel to avoid overlaps.

DMX Channel Protocol - 8 bit				
MODE	CHANNELS	DMX CHANNEL POSITION	DMX VALUE	VALUE
CCT	3	1. DIMMER	0 - 255	0 ÷ 100 %
		2. COLOR TEMPERATURE	0 - 255	6500 - 2700
		4. STROBE	0 ÷ 10 11 ÷ 255	strobe off freq. strobe 1 ÷ 24
TELEVISION*	3	1. DIMMER	0 - 255	0 ÷ 100 %
		2. WHITE RANGE	0 - 255	1 ÷ 4
		3. FREQUENCY	0 - 255	4 ÷ 24
PAPARAZZI*	3	1. DIMMER	0 - 255	0 ÷ 100 %
		2. INTERVAL	0 - 255	1 ÷ 10 %
		3. BULB TYPE	0 - 255	0 ÷ 2
LIGHTNING*	3	1. DIMMER	0 - 255	0 ÷ 100 %
		2. COLOR TEMPERATURE	0 - 255	6500 - 2700
		3. INTERVAL	0 ÷ 255	1 ÷ 20
DMX Channel Protocol - 16 bit				
MODE	CHANNELS	DMX CHANNEL POSITION	DMX VALUE	VALUE
CCT	8	1. DIMMER - byte 1	0 - 65535	0 ÷ 100 %
		2. DIMMER - byte 2		
		3. COLOR TEMPERATURE - byte 1	0 - 65535	6500 - 2700
		4. COLOR TEMPERATURE - byte 2		
		5. GN COMPENSATION - byte 1	0 ÷ 500	∅
		6. GN COMPENSATION - byte 2	501 ÷ 65535	-1,00 ÷ + 1,00
		7. STROBE - byte 1	0 ÷ 2620	strobe off
		8. STROBE - byte 2	2621 ÷ 65535	-1,00 ÷ + 1,00
TELEVISION *	6	1. DIMMER - byte 1	0 - 65535	0 ÷ 100 %
		2. DIMMER - byte 2		
		3. WHITE RANGE - byte 1	0 - 65535	1 ÷ 4
		4. WHITE RANGE - byte 2		
		5. FREQUENCY - byte 1	0 - 65535	4 ÷ 24
		6. FREQUENCY - byte 2		
PAPARAZZI*	6	1. DIMMER - byte 1	0 - 65535	0 ÷ 100 %
		2. DIMMER - byte 2		
		3. INTERVAL - byte 1	0 - 65535	1 ÷ 10 %
		4. INTERVAL - byte 2		
		5. BULB TYPE - byte 1	0 - 65535	0 ÷ 2
		6. BULB TYPE - byte 2		
LIGHTNING*	6	1. DIMMER - byte 1	0 - 65535	0 ÷ 100 %
		2. DIMMER - byte 2		
		3. COLOR TEMPERATURE - byte 1	0 - 65535	6500 - 2700
		4. COLOR TEMPERATURE - byte 2		
		5. INTERVAL - byte 1	0 ÷ 65535	1 ÷ 20
		6. INTERVAL - byte 2		

**Channel in use only the Dual Color version.*

USB port

Use USB port for firmware updates.

Update the Firmware

1. Copy the file on an USB Pendrive (FAT32 formatted) in the main root;
2. Switch off the equipment and insert the USB Pendrive;
3. Switch on the equipment;

4. Wait until display backlight flashes (it takes several minutes and red led must toggle for all time long);
5. Switch off the equipment;
6. Extract the Pendrive and switch on the equipment: the firmware is updated.

MENU e submenus

- Select **"EXIT"** to return to the current mode.
- Select **"BACK"** to return to the previous menu.

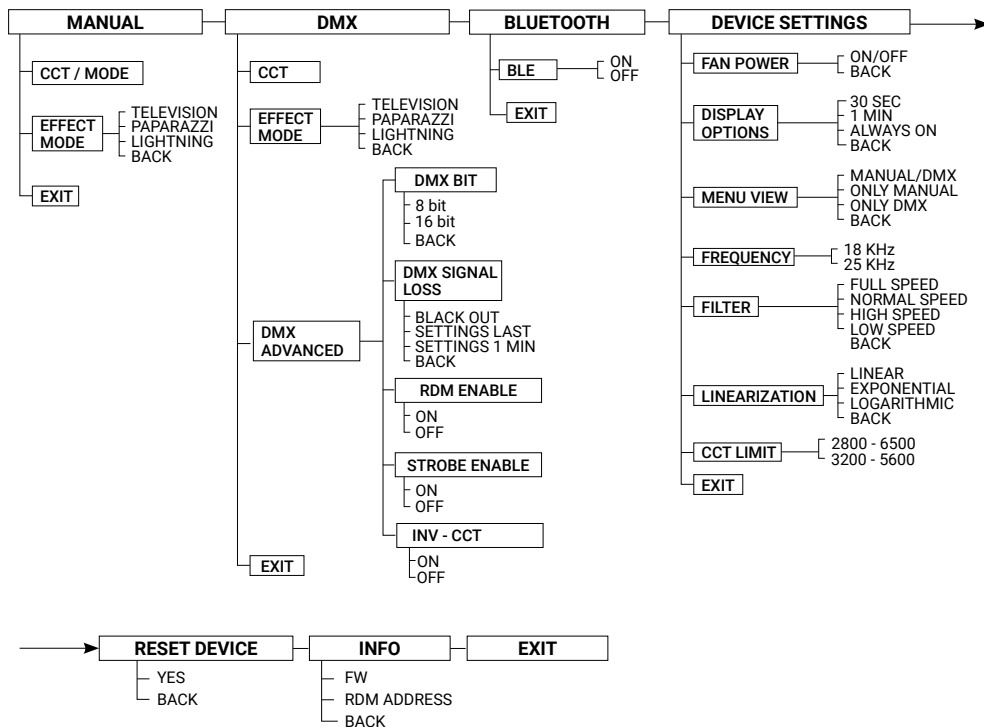

NOTE: After 1 minute of inactivity in the menu, the device automatically exits and returns to the last selected mode.

Package Contents for Actionpanel

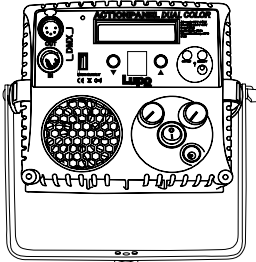

Actionpanel

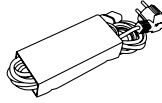

**AC Power
Cord Cable**

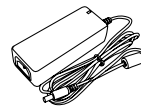

AC Adapter *
AC input: 100 V - 240 V
DC output: 24 V

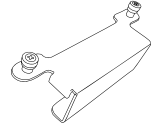

**AC Adapter
Mounting
Bracket**

▲ ATTENTION: Please keep the original package of the product in a safe place for warranty reasons.

Package Contents for Superpanel 30 and Ultrapanel 30

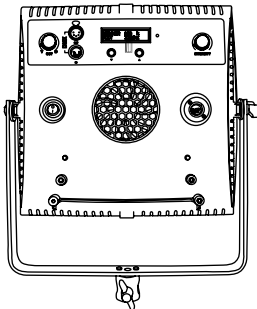

**Superpanel 30
Ultrapanel 60**

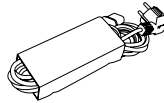

**AC Power
Cord Cable**

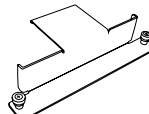

**AC Adapter
Mounting
Bracket**

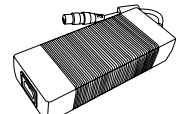

AC Adapter
AC input: 100 V - 240 V
DC output: 24 V

▲ ATTENTION: Please keep the original package of the product in a safe place for warranty reasons.

Package Contents for Superpanel 60 and Ultrapanel 60

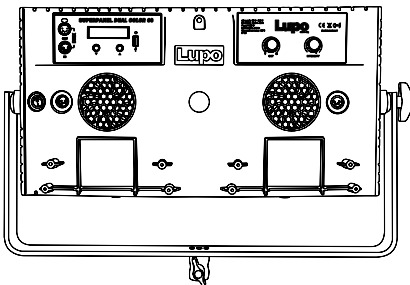

**Superpanel 60
Ultrapanel 60**

**AC Power Cord with
AC Power Cord Splitter**

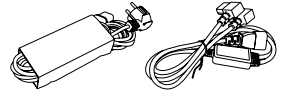

**2x AC Adapter
Mounting
Bracket**

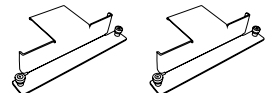

2x AC Adapter
AC input: 100 V - 240 V
DC output: 24 V

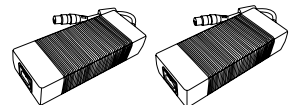

▲ ATTENTION: Please keep the original package of the product in a safe place for warranty reasons.