



Type(s)
Project
Date
Notes

GENERAL INFORMATION

The ArcSystem Pro D4 CV Driver is an ideal product for driving a wide range of constant voltage LED loads. The versatile feature set includes optional emergency variants as well as ArcMesh wireless control for easy retrofit applications. Designed to simplify and centralize your driver systems the ArcSystem Pro D4 Driver line is the perfect tool for new design installations and retrofit projects alike.

The D4 CV line is available in 150, 350, and 700 variants with maximum load capabilities reaching up to 528 W. The compact 150 version is wall-mounted, while the 350 and 700 versions include both wall-mounting and rack-mounting options.

D4 CV Drivers are compatible with 24 VDC constant voltage LED loads, making them ideal for applications such as linear tape installation. Like all ArcSystem Pro drivers, the D4 CV family is available in a wired-only DMX version with RDM or an ArcMesh wireless version for hassle-free installation.

GENERAL INFORMATION

APPLICATIONS

- Auditoriums
- Worklights
- Lobbies
- Houses of worship
- Museums
- Studio
- Retail

FEATURES

- Constant voltage designed for use with third party fixtures and tape light
- Smooth dimming to zero
- Silent operation
- Rack- and Wall-mounted options

ORDERING INFORMATION

ArcSystem D4 Driver

MODEL	CONTROL	TYPE	MODEL	CONNECTION	MATERIAL	MOUNTING	REGULATORY
ARCPD4D - D4 Standard	(Blank) - DMX/ ArcMesh	CV24 - Constant Voltage	(Blank) - 150 Driver	T - Terminal	M - Metal	R - Rack-mount W - Wall-mount	(Blank) - UL compliant -CE - CE Rated
ARCPED4D - D4 Emergency	RDM - DMX/ RDM		350 - 350 Driver 700 - 700 Driver			Note: 150 model is wall-mount only	

Example: ARCPD4DCV24350TMR - ArcSystem D4 Driver, 24VDC Constant Voltage, 350 Driver, Terminal Connection, Metal Rack-mounted, UL compliant



SPECIFICATION

Control

	ARCMESH MODEL	RDM MODEL
Protocols	DMX and ArcMesh wireless	DMX and RDM without wireless
RDM configuration	No	Yes
UI type	ArcSystem PC configuration app	None
DMX footprint	4 channels	
Local control	No	
Input method	DMX-512 via RJ45 etherCON connector	
Notes	ArcMesh wireless control requires optional TX1 transmitter	

Electrical

Voltage Input	150 - 100-277 VAC 50/60 Hz 350 - 100-240 VAC 50/60 Hz 700 - 100-240 VAC 50/60 Hz
Output	4 x 24 VDC Constant Voltage output with PWM dimming
Inrush	150 - 15 A at all rated voltages 350 - 15 A at all rated voltages 700 - 15 A at all rated voltages
Wattage (max / standby)	150 max 150 W / standby 11 W 350 max 264 W / standby 10 W 700 max 528 W / standby 15 W
Current draw at 120 VAC	150 - 3.7 A 350 - 11 A 700 - 22 A
Power factor	> 0.9
Maximum cable length from driver to luminaire	100 m (328 ft)

Thermal

Ambient operating temp	0–40° C (32–104° F)
Fan (controllable)	150 - N/A (convection cooled) 350 / 700 - thermally regulated integral cooling fans
BTUs/hour (120 V/ 240 V)	150 - 511 BTU/hr 350 - 900 BTU/hr 700 - 1801 BTU/hr

Physical

Materials	Galvanized steel construction
Color options	Black
Mounting options	Wall-mount - four screw holes in rear plate Rack-mount - 1U Standard rack mounting
IP rating	IP-20 (dry locations only)
Weight	150 : 1.9 kg (4.2 lb) 350 : 4.3 kg (9.4 lb) 700 : 5 kg (11.1 lb)

Warranty

Driver	5 years
Website	etconnect.com/Support/Warranty.aspx

Regulatory and Compliance

Approved regulatory standards	Standard version cULus - UL8750 and CSA C22.2 No. 250.13 CE Compliant Emergency version cULus – UL924 and CSA C22.2 No. 141 CE Compliant Wall mount version Suitable for use in air handling spaces by NEC 300.22(C)(3)
-------------------------------	--

EMERGENCY CONNECTION

A dual-input emergency version of this driver is available. Emergency drivers have two line-voltage leads that are wired to the product and have the following functions:

- Normal power/emergency power
- Normal power sense input

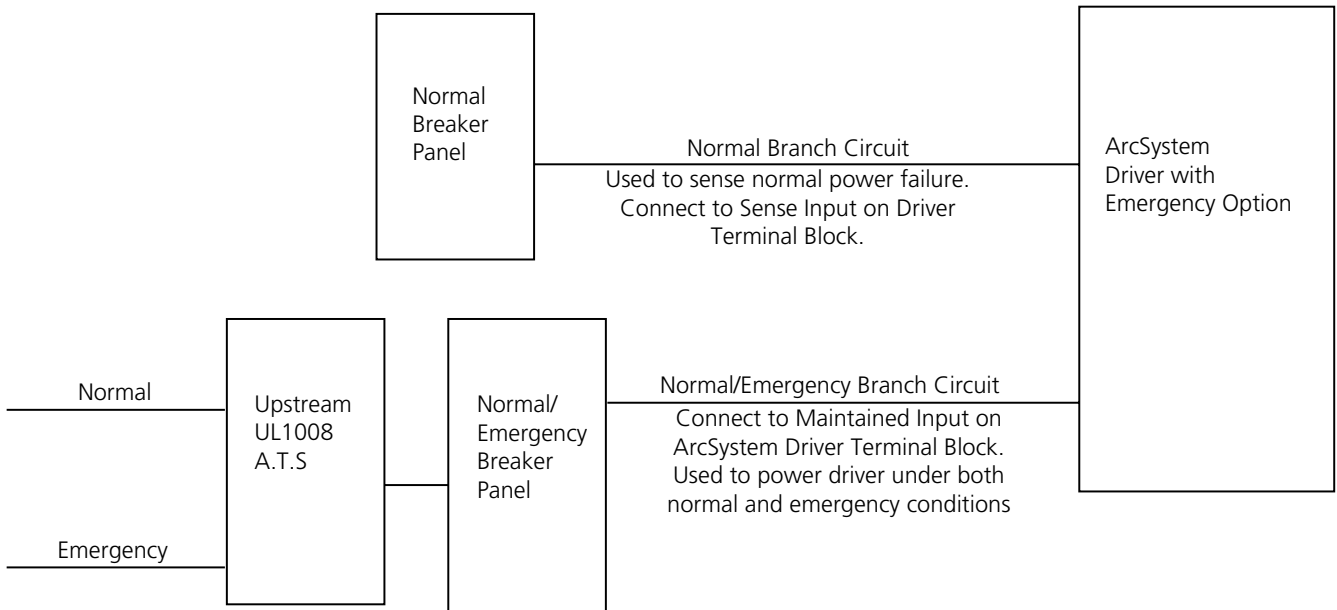

If normal power to the sense input is lost, the driver will force the luminaires on at 100% overriding all other control signals. There is no control of the driver/luminaires via wireless ArcMesh or wired DMX until normal power is restored at the sense input.

LUMINAIRE CONNECTION

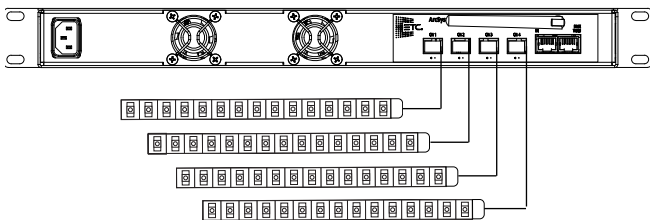

ArcSystem Pro D4 CV Drivers can be used within system limits to provide power to a wide range of third party constant voltage loads. Use with LED tape to provide four channels of control, or bridge channels together to provide more power for longer runs

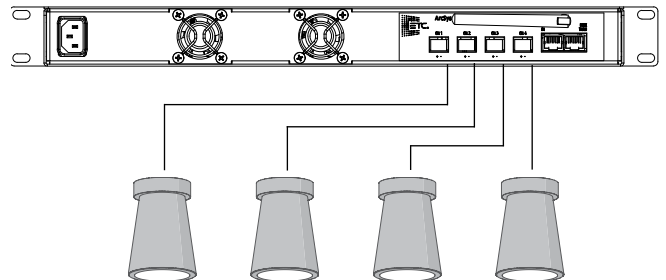

ArcSystem Pro D4 CV Drivers are used with 3rd party constant voltage luminaires to control multiple fixtures from a single driver, reducing system costs, offering easy retrofit, and improving system integration opportunities.

D4 Driver Maximum System Limits

	150 CV DRIVER	350 CV DRIVER	700 CV DRIVER
Output Type	24 VDC constant voltage	24 VDC constant voltage	24 VDC constant voltage
Channels per unit	4	4	4
Max current per channel	2 A	3 A	6.1 A
Max power per channel	50 W	72 W	146 W
Max power for driver	150 W	264 W	528 W
For use with	Compatible 3rd party luminaires	Compatible 3rd party luminaires	Compatible 3rd party luminaires

Notes

- Kits to bridge driver outputs are provided with each driver. See installation manual for more details
- For output wiring size refer to the driver installation manual.
- Visit etconnect.com/compatibility for more information on 3rd party luminaire integration

D4 CV Driver Bridge Specifications

D4 CV DRIVER MODEL	BRIDGE CONFIGURATITON	MAX CURRENT PER CHANNEL	MAX POWER PER BRIDGED CHANNEL
D4 Driver 150 CV	2 channels bridged into 1	2.2 A	53 W
	3 channels bridged into 1	3.4 A	79 W
	4 channels bridged into 1	4.4 A	110 W
D4 Driver 350 CV Wall-mount	2 channels bridged into 1	5.8 A	140 W
	3 channels bridged into 1	8.25 A	198 W
	4 channels bridged into 1	11 A	264 W
D4 Driver 350 CV Rack-mount	2 channels bridged into 1	5.6 A	134 W
	3 channels bridged into 1	8.6 A	206 W
	4 channels bridged into 1	11 A	264 W
D4 Driver 700 CV Wall-mount	2 channels bridged into 1	12 A	288 W
	3 channels bridged into 1	Option not available	
	4 channels bridged into 1		
D4 Driver 700 CV Rack-mount	2 channels bridged into 1	11 A	264 W
	3 channels bridged into 1	Option not available	
	4 channels bridged into 1		

PHYSICAL

Product Dimensions

MODEL	HEIGHT		WIDTH		DEPTH	
	in	mm	in	mm	in	mm
D4 Driver 150 Wall	11.09	282	8.20	209	2.28	58
D4 Driver 350/700 Wall	15.26	388	12.76	324	3.08	78
D4 Driver 350/700 Rack	1.74	44	19.00	483	9.63	245

Product Weight

MODEL	WEIGHT		SHIPPING WEIGHT	
	lb	kg	lb	kg
D4 Driver 150 - Wall	4.2	1.9	5.2	2.3
D4 Driver 350 - Wall	9.4	4.3	10.6	4.8
D4 Driver 350 - Rack	12.0	5.5	14.3	6.5
D4 Driver 700 - Wall	11.1	5	12.3	5.6
D4 Driver 700 - Rack	14.8	6.7	17.1	7.8

D4 DRIVER 150 CV - WALL MOUNT

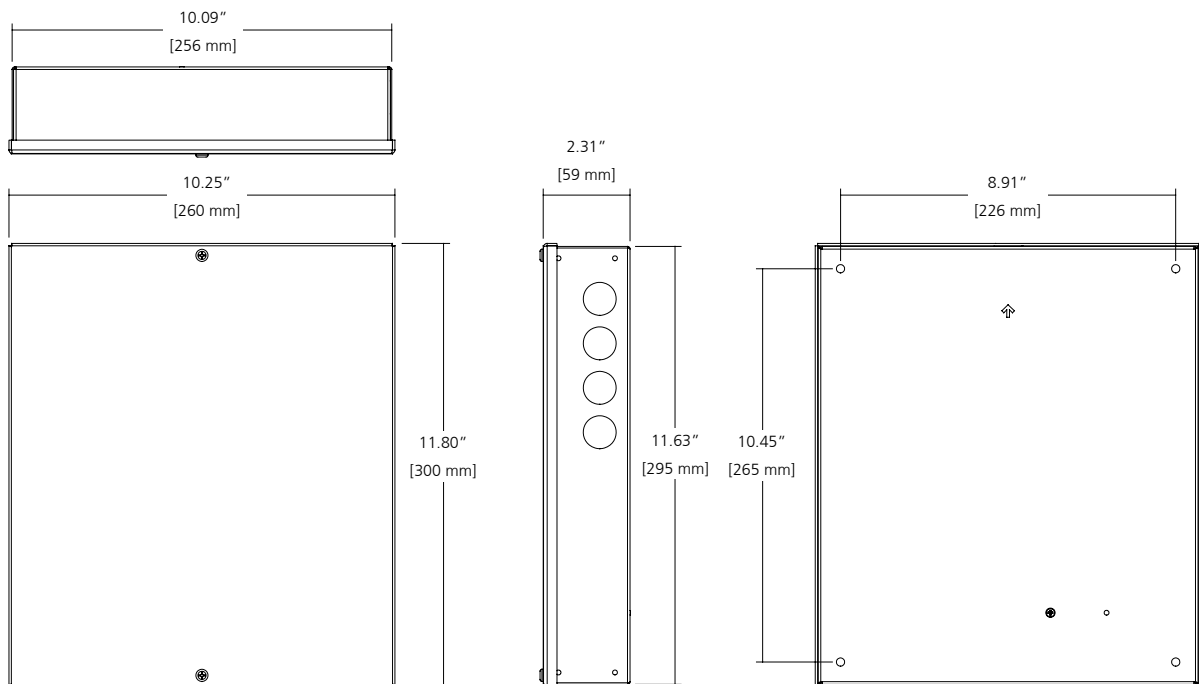

ARCSYSTEM PRO D4 DRIVER 350 CV - WALL MOUNT

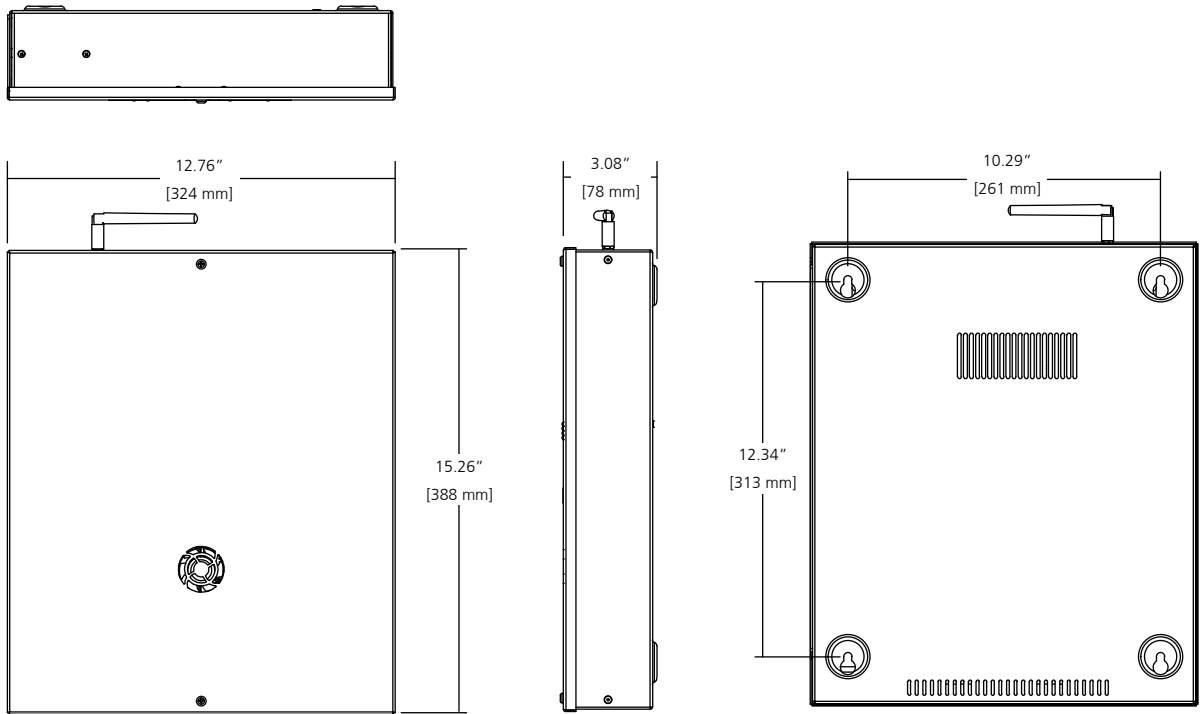

ARCSYSTEM PRO D4 DRIVER 700 CV - WALL MOUNT

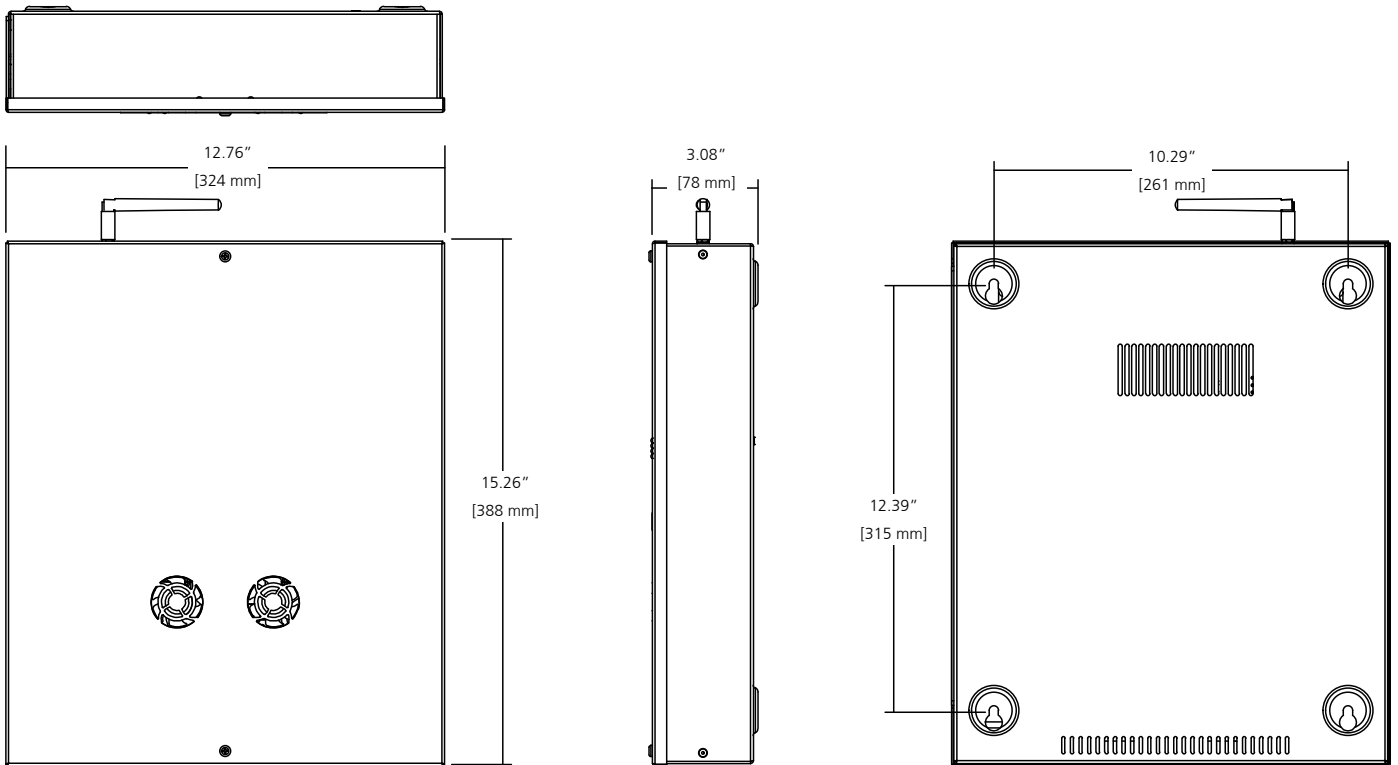

ARCSYSTEM PRO D4 DRIVER 350/700 CV - STANDARD RACK MOUNT

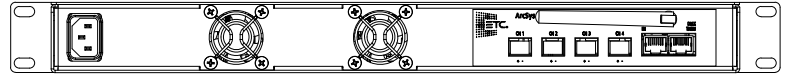

*350 Driver does not have the center mounted fan or vent

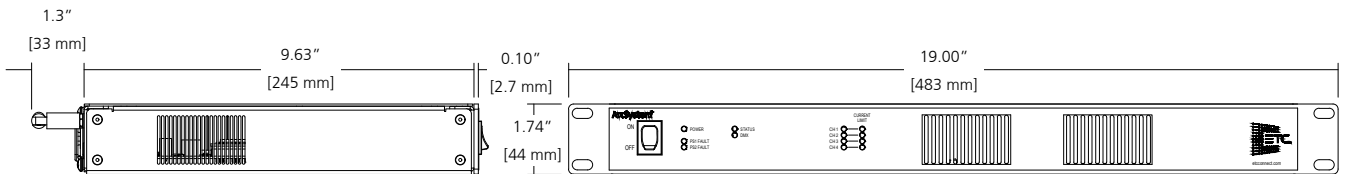
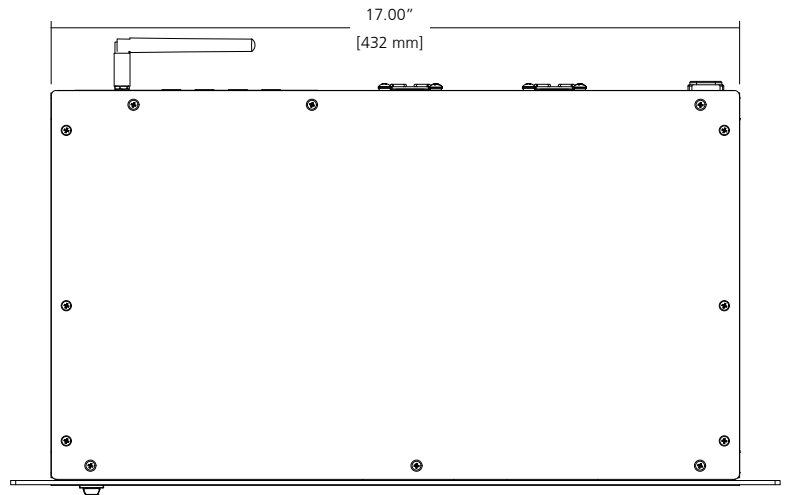

Corporate Headquarters • Middleton, WI USA
 Global Offices • London, UK • Rome, IT • Holzkirchen, DE • Paris, FR • Hong Kong • Dubai, UAE •
 Singapore • New York, NY • Orlando, FL • Los Angeles, CA
 Copyright©2020 ETC. All Rights Reserved. All product information and specifications subject to change. Rev D 2020-11
 Trademark and patent info: etconnect.com/IP