

Source Four LED Series



Type(s)  
Project  
Date  
Notes

GENERAL INFORMATION

Over a decade of research comes together in the Source Four LED Series 3 fixture. ETC brings the eight-color Lustr X8 array and the tunable white light Daylight HDR array to the professional stage with this fixture. The deep red LEDs in both arrays reveal richer skin tones, bring a deeper dimension to your scenery, and add warmth to sunsets and firelight. Additional features include wireless DMX/RDM through City Theatrical's Multiverse® technology, contactless programming and control using NFC and ETC's Set Light app, and an intuitive user interface featuring a color picker and action-responsive backlit encoders.

ORDERING INFORMATION

Source Four LED Series 3 Light Engine with XDLT Shutter Barrel

(For use with XDLT fixed-field lens tubes only)

MODEL	DESCRIPTION	ETL PART NUMBER	CE PART NUMBER
S4LEDS3LS-0	Source Four LED Series 3 Lustr X8 with XDLT shutter barrel, black	7462A1051	7462A1251
S4LEDS3DS-0	Source Four LED Series 3 Daylight HDR with XDLT shutter barrel, black	7462A1071	7462A1271

Source Four LED Series 3 Light Engine Body

(For use with standard barrels, zoom lens tubes and retrofit of existing fixtures)

MODEL	DESCRIPTION	ETL PART NUMBER	CE PART NUMBER
S4LEDS3L-0	Source Four LED Series 3 Lustr X8, body only, black	7462A1050	7462A1250
S4LEDS3D-0	Source Four LED Series 3 Daylight HDR, body only, black	7462A1070	7462A1270

Color options: -1 = white, -5 = silver, -8 = custom colors

Fixture ships with a gobo holder, c-clamp (not included with CE fixtures) and a 1.5 m powerCON TRUE1 TOP® power-input cable with a connector of choice.

See page 9 for connector options.

Please note: Lens tubes to be ordered separately. When using Source Four LED Series 3 with standard and EDLT lens tubes, order light engine and Source Four LED shutter barrel (7060A2012-K) see page 8 for information.



PRODUCT SPECIFICATIONS

Source

LED details	90 Lumileds LUXEON® C and CZ
Max lumens	<b>Lustr X8:</b> 10,889 <b>Daylight HDR:</b> 14,214
Lumens per watt	<b>Lustr X8:</b> 35 <b>Daylight HDR:</b> 42
L70 rating (hours to 70% output)	>54,000

Color

Colors used	<b>Lustr X8:</b> Deep Red, Red, Amber, Lime, Green, Cyan, Blue, Indigo <b>Daylight HDR:</b> Deep Red, Red, Mint, Cyan, Blue, Indigo
Color temperature range	1900–10450 K
Calibrated array	Yes
Red shift	Yes (selectable)

Optical

Beam angle range	Swappable lens tubes between 5°–90°
Gate size	80 mm
Aperture size	6.25–17.5 in (depending on lens tube)
Pattern projection	Yes
Pattern size	A or B
Camera flicker control/Hz range	Yes: 5 kHz, 25 kHz
Notes	Can be used with LED CYC and Fresnel adapters

Control

Input method	5-Pin XLR, Multiverse wireless and NFC
Protocols	DMX-512, RDM, City Theatrical Multiverse, NFC
Modes (footprint)	5 modes (1–12 channels)
RDM configuration	Yes
UI type	Full color display
Local control	Yes
Onboard presets	Yes (12)
Onboard sequences	Yes
Onboard effects	No
FixtureLink	Yes
Notes	15-bit virtual dimming engine

All LED sources experience some lessening of light output and some color shift over time. LED output will vary with thermal conditions. In individual situations, LEDs will be used for different durations and levels. This can eventually lead to minor alterations in color performance, necessitating slight adjustments to presets, cues or programs.

Electrical

Voltage range	100–240 VAC 50/60 Hz
Input method	AC via Neutrik powerCON TRUE1 TOP
Inrush	40 A at 120 V (First half-cycle) 80 A at 230 V (First half-cycle)
Fixtures per circuit*	5 (link up to 4 via Power Thru connector) Note: TRUE1 connector rated for 20 A (120 V / 60 Hz) and 16 A (240 V / 50 Hz)
Wattage typical Direct at Full (Idle)	<b>Lustr X8:</b> 307 (6.3) W at 120 V 305 (4.7) W at 230 V <b>Daylight HDR:</b> 340 (6.3) W at 120 V 330 (4.7) W at 230 V
Current draw	<b>Lustr X8:</b> 2.6 A at 120 V 1.35 A at 230 V <b>Daylight HDR:</b> 2.85 A at 120 V 1.5 A at 230 V

\*All measurements are for 120 V, 60 Hz. Results may vary in different regions.

Thermal

Ambient operating temp	0°C–40° C (32°F–104° F)
Fan (controllable)	Yes (yes)
Droop compensation	Yes
dB range	34 dBA average at 1 m
BTUs/hour	<b>Lustr X8:</b> 1,047 <b>Daylight HDR:</b> 1,159

Physical

Materials	Die-cast, all metal housing
Color options	Black, white, silver, or custom color
Mounting options	Yoke, cyc floor stand (sold separately)
IP rating	IP20
Weight	With barrel: 8.87 kg (19.55 lb) Without barrel: 6.76 kg (14.90 lb)
Included accessories	Hanging yoke, 1.5 m power cable, A-size gobo holder, c-clamp*
Notes	- Positive locking double-clutch fixture body - Slot for glass or stainless steel patterns and soft focus diffuser - Wide accessory slot with sliding cover for motorized pattern device or iris

\*(not included with CE fixtures)

Warranty

Fixture	5 years
LED array	10 years

Regulatory and Compliance

Approved regulatory standards	cETLus Listed Conforms to UL1573 Certified to C22.2 C22.#166 CE Compliant
-------------------------------	--

PRODUCT FEATURES



**DEEP RED**

Over a decade of research brings the addition of the deep red LED to Series 3. This LED expands the gamut for richer colors, healthier skin tones, and a higher quality white light.



**WIRELESS CONTROL**

Activate wireless DMX functionality with City Theatrical's Multiverse transmitter and configure your fixtures via NFC using the Set Light app.



**XDLT LENS TUBES**

Increase fixture brightness and improve pattern projection clarity and contrast when used with XDLT lens tubes.

COLOR METRIC INFORMATION

SOURCE FOUR LED SERIES 3 LUSTR X8 3200 K TM-30-18

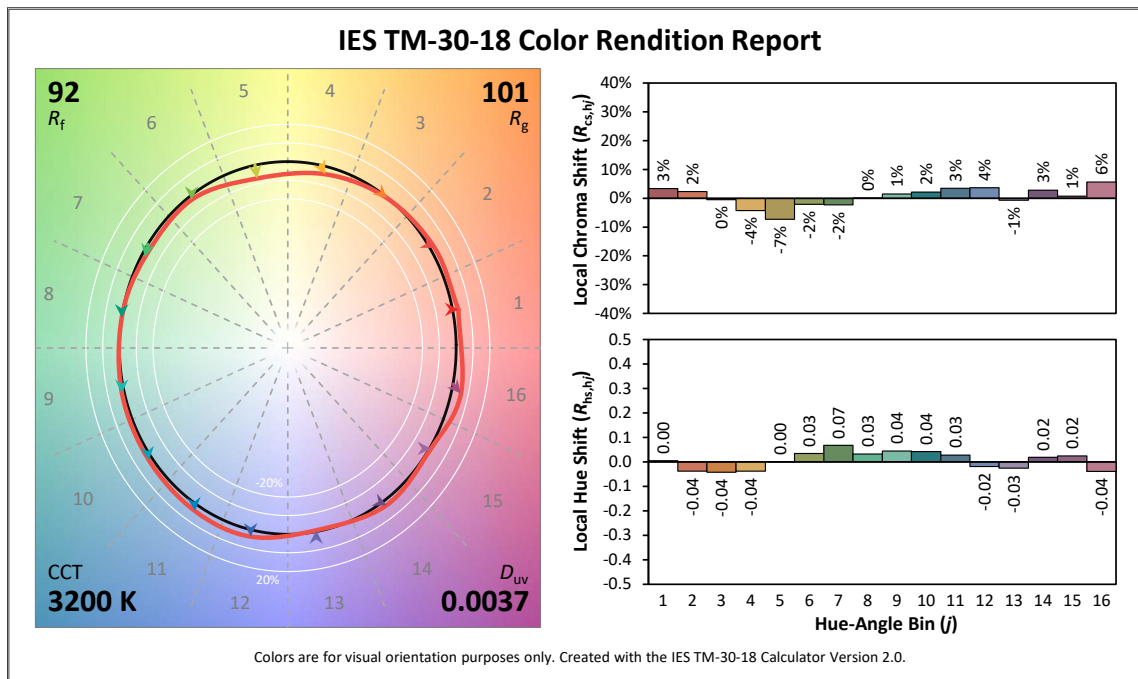

COLOR METRIC INFORMATION

SOURCE FOUR LED SERIES 3 LUSTR X8 4500 K TM-30-18

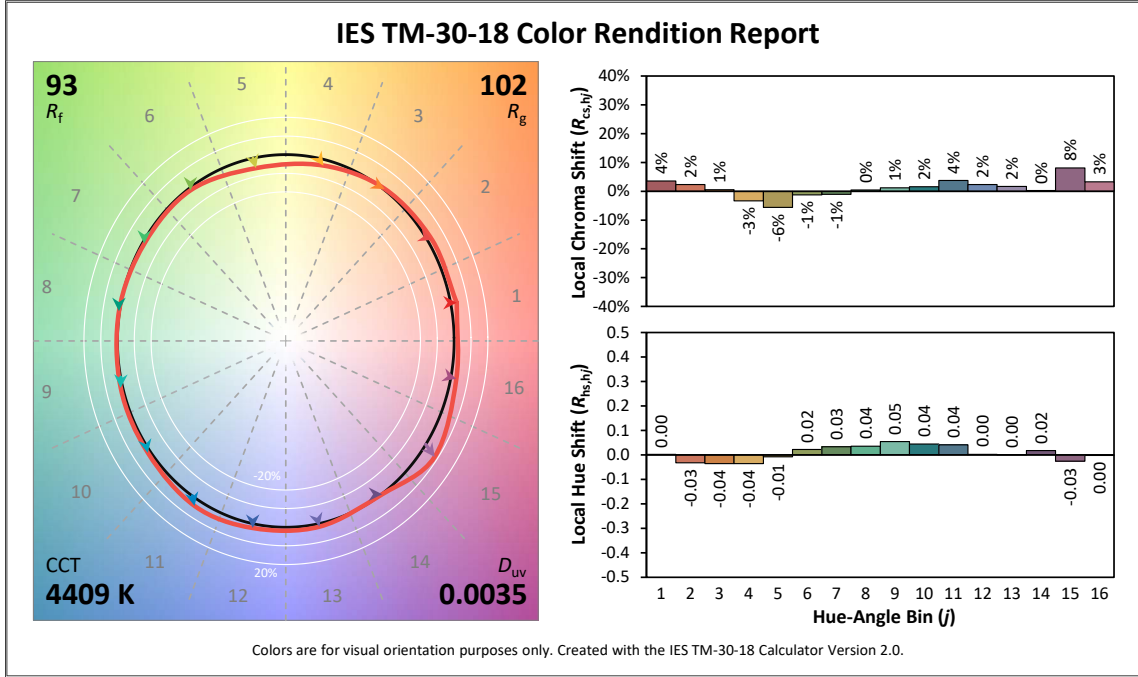

SOURCE FOUR LED SERIES 3 LUSTR X8 5600 K TM-30-18

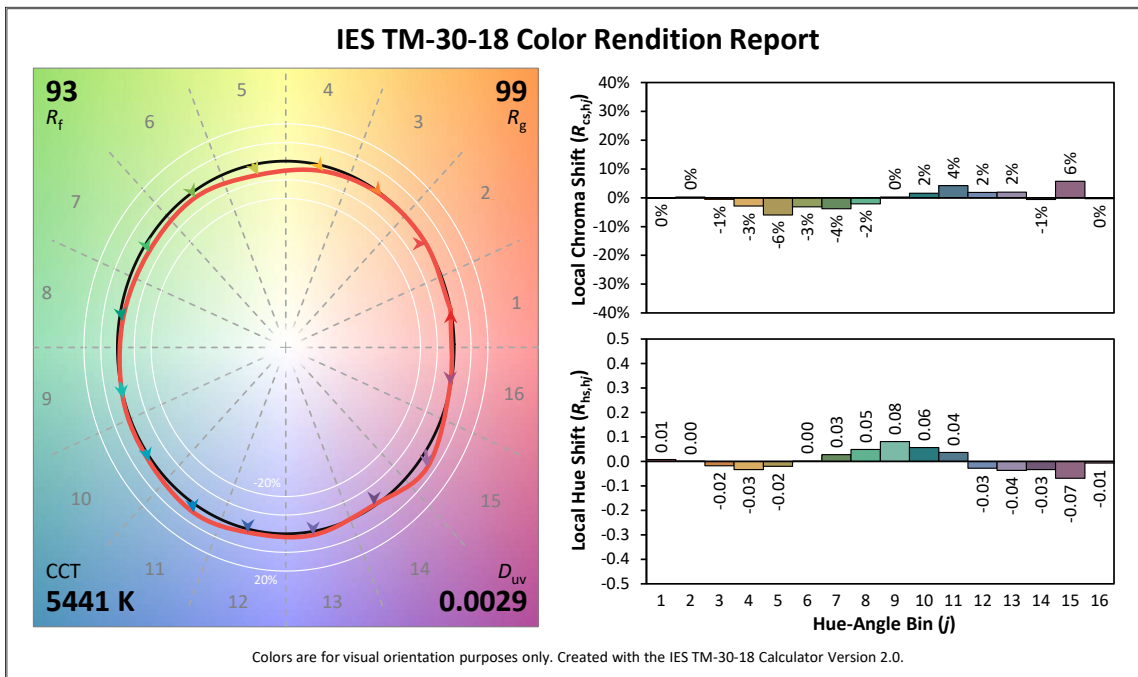

COLOR METRIC INFORMATION

SOURCE FOUR LED SERIES 3 DAYLIGHT HDR 3200 K TM-30-18

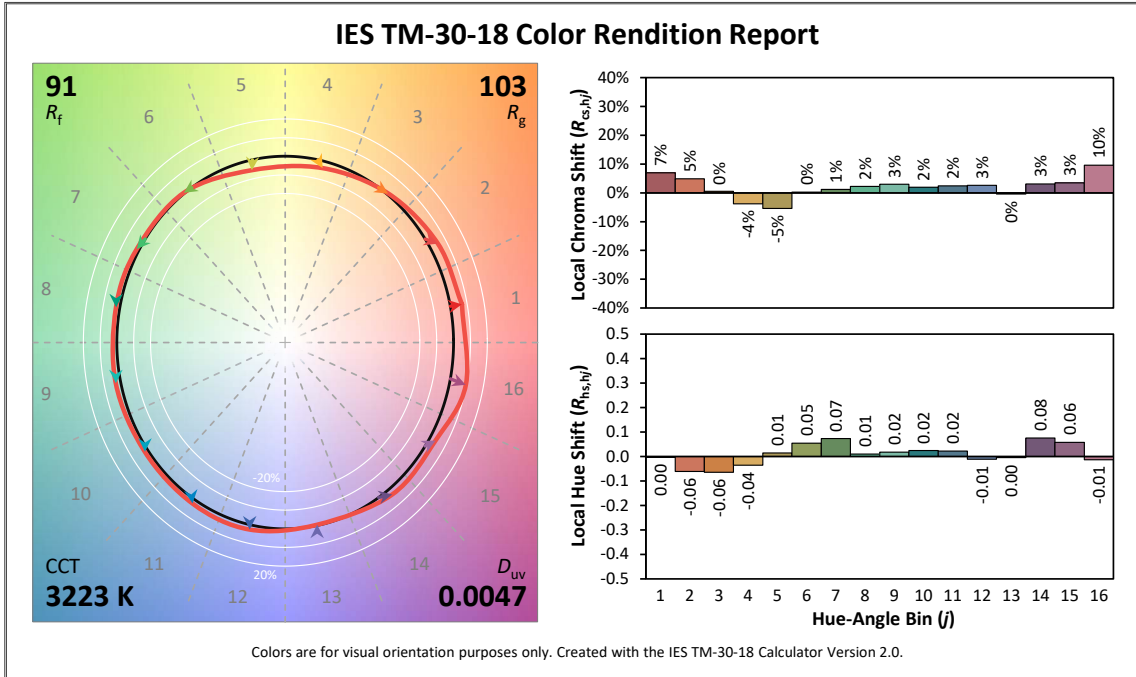

SOURCE FOUR LED SERIES 3 DAYLIGHT HDR 4500 K TM-30-18

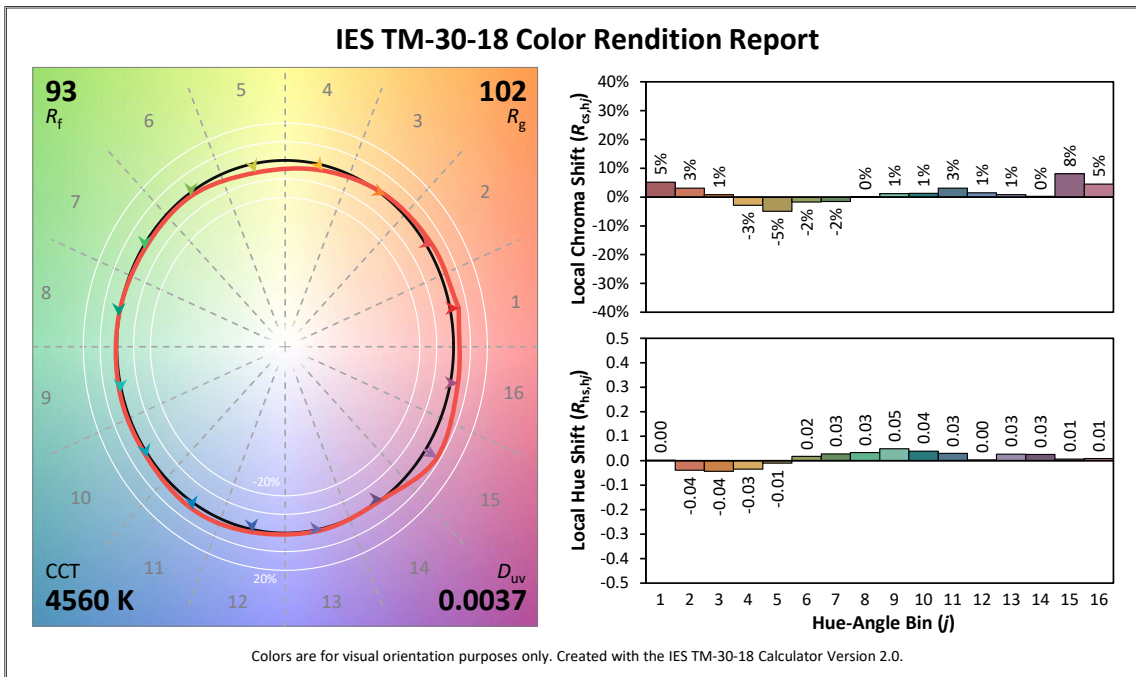

COLOR METRIC INFORMATION



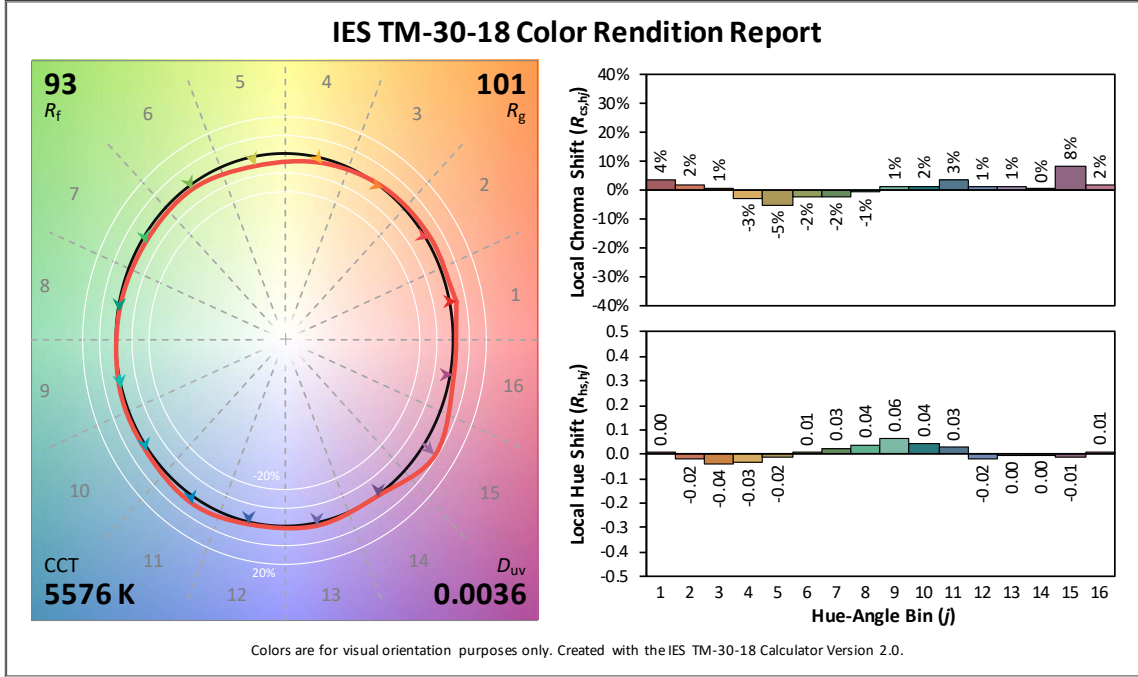





SOURCE FOUR LED SERIES 3 DAYLIGHT HDR 5600 K TM-30-18



TYPE	LUSTR X8 3200 K	LUSTR X8 4500 K	LUSTR X8 5600 K
CRI Ra	93	94	98
TLCI	96	97	97
SSI	78	70	73

TYPE	DAYLIGHT HDR 3200 K	DAYLIGHT HDR 4500 K	DAYLIGHT HDR 5600 K
CRI Ra	86	93	95
TLCI	91	96	98
SSI	71	71	72

PHOTOMETRY INFORMATION

Lens Tube	Series 3 Lustr X8		Series 3 Daylight HDR		115V/575W LL HPL		120V/750W SL HPL		230V/750W LL HPL	
	Lumens	Candela	Lumens	Candela	Lumens	Candela	Lumens	Candela	Lumens	Candela
 XDLT 5	6,031	630,344	7,074	686,006						
 XDLT 10	7,823	375,028	9,600	412,304						
 XDLT 14*	7,544	185,125	9,191	200,085						
 XDLT 19*	8,921	144,856	10,708	156,524						
 XDLT 26*	10,120	82,357	12,346	89,668						
 XDLT 36*	10,426	47,215	12,733	51,954						
 XDLT 50	8,499	26,017	10,404	28,348						
 XDLT 70	TBD	TBD	12,271	18,037						
<b>EDLT 19</b>	5,349	75,742	6,606	88,849	7,287	145,803	13,012	260,363	7,677	104,145
<b>EDLT 26</b>	9,399	81,612	11,278	88,180	8,631	102,089	15,412	182,301	9,093	72,920
<b>EDLT 36</b>	9,302	52,150	11,331	60,325	7,992	55,190	14,271	98,553	8,420	39,421
<b>EDLT/LED 50</b>	8,045	24,769	9,675	29,105	8,085	23,224	14,437	41,471	8,518	16,588
<b>5</b>	3,523	398,072	4,190	431,270	5,247	753,340	9,370	1,345,250	5,528	538,100
<b>10</b>	5,370	236,941	6,396	264,915	6,678	438,654	11,925	783,310	7,036	313,324
<b>14</b>	5,359	114,625	6,586	125,582	7,196	226,677	12,850	404,780	7,582	161,912
<b>19</b>	4,482	70,341	5,364	76,233	6,261	136,371	11,180	243,520	6,596	97,408
<b>26</b>	5,849	54,998	7,055	60,587	7,666	98,703	13,690	176,255	8,077	70,502
<b>36</b>	9,732	46,186	11,687	50,496	7,974	50,896	14,240	90,885	8,402	36,354
<b>50</b>	7,893	24,669	9,914	28,663	7,829	25,564	13,980	45,650	8,248	18,260
<b>70</b>	9,926	16,156	11,928	17,679	9,033	12,471	16,130	22,270	9,517	8,908
<b>90</b>	10,259	11,137	12,359	12,366	7,395	6,345	13,205	11,330	7,791	4,532
<b>15-30 Zoom Nar</b>	5,907	120,817	7,017	130,805	6,418	221,514	11,460	395,560	6,761	158,224
<b>15-30 Zoom Mid</b>	6,640	88,295	7,855	96,585	6,418	101,744	11,460	181,685	6,761	72,674
<b>15-30 Zoom Wide</b>	5,732	41,321	6,784	44,035	6,698	59,186	11,960	105,690	7,056	42,276
<b>25-50 Zoom Nar</b>	10,889	72,877	13,054	80,448	8,420	84,417	15,035	150,745	8,871	60,298
<b>25-50 Zoom Mid</b>	9,977	40,162	11,903	48,985	8,568	53,368	15,300	95,300	9,027	38,120
<b>25-50 Zoom Wide</b>	9,555	32,935	11,297	34,862	8,277	35,549	14,780	63,480	8,720	25,392

\* Lenses with color correction technology

**PREFERRED LENSING OPTIONS**

(Lenses sold separately)

**XDLT Lenses**

Note: XDLT lens tubes require the XDLT shutter barrel (7462A2012-K)

MODEL	DESCRIPTION	ACCESSORY SIZE	WEIGHT	PART NUMBER
XDLT5	5° XDLT lens tube with lens installed, black	17.5 in	4.45 kg (9.8 lb)	7462A2002-K
XDLT10	10° XDLT lens tube with lens installed, black	14 in	2.77 kg (6.1 lb)	7462A2003-K
XDLT14	14° XDLT lens tube with lens installed, black	10 in	7.39 kg (16.3 lb)	7462A2004-K
XDLT19	19° XDLT lens tube with lens installed, black	10 in	6.4 kg (14.1 lb)	7462A2005-K
XDLT26	26° XDLT lens tube with lens installed, black	7.5 in	3.95 kg (8.7 lb)	7462A2006-K
XDLT36	36° XDLT lens tube with lens installed, black	7.5 in	3.95 kg (8.7 lb)	7462A2007-K
XDLT50	50° XDLT lens tube with lens installed, black	7.5 in	2.59 kg (5.7 lb)	7462A2008-K
XDLT70	70° XDLT lens tube with lens installed, black	7.5 in	2.59 kg (5.7 lb)	7462A2009-K

For white, add '-1' to the model number. Add '1' before the 'K' to the part number.

For silver, add '-5' to the model number. Add '5' before the 'K' to the part number.

For custom colors, add '-8' to the model number. Add '8' before the 'K' to the part number.

**EDLT and Standard Lenses**

Note: EDLT and Standard lens tubes require a Source Four LED shutter barrel (7060A2012-K)

MODEL	DESCRIPTION	ACCESSORY SIZE	WEIGHT	PART NUMBER
LED50LT	LED-specific 50° EDLT with lenses installed	7.5 in	2.0 kg (4.4 lb)	7460A2008
436EDLT	36° EDLT w/lens installed	6.25 in	2.0 kg (4.4 lb)	7060A2048
426EDLT	26° EDLT w/lens installed	6.25 in	2.0 kg (4.4 lb)	7060A2047
419EDLT	19° EDLT w/lens installed	6.25 in	1.91 kg (4.2 lb)	7060A2046
490LT	90° w/lens installed	7.5 in	1.72 kg (3.8 lb)	7060A2052-K
470LT	70° w/lens installed	7.5 in	1.72 kg (3.8 lb)	7060A2051-K
414LT	14° w/lens installed	7.5 in	1.91 kg (4.2 lb)	7060A2050-K
410LT	10° w/lens installed	12 in	1.95 kg (4.3 lb)	7060A2001-K
405LT	5° w/lens installed	14 in	3.27 kg (7.2 lb)	7060A2000-K

For white, add '-1' to the model number. Add '1' before the 'K' to the part number.

For silver, add '-5' to the model number. Add '5' before the 'K' to the part number.

For custom colors, add '-8' to the model number. Add '8' before the 'K' to the part number.

**Zoom Lens Assemblies**

Use with light-engine body models.

MODEL	DESCRIPTION	ACCESSORY SIZE	WEIGHT	PART NUMBER
41530LT	Source Four 15°–30° Zoom lens assembly	7.5 in	7.44 kg (16.4 lb)	7060A2030-K
42550LT	Source Four 25°–50° Zoom lens assembly	7.5 in	7.44 kg (16.4 lb)	7060A2032-K

**LED Adapters**

MODEL	DESCRIPTION	ACCESSORY SIZE	WEIGHT	PART NUMBER
S4LEDCYC	LED Cyc adapter	NA	2.1 kg (4.5 lb)	7460A2011
S4LEDFRES	LED Fresnel adapter	7.5 in	4.2 kg (9.2 lb)	7460A2016



## ADDITIONAL ORDERING INFORMATION

## Fixture Accessories

MODEL	DESCRIPTION	PART NUMBER
400CC	C-Clamp (included - ETL fixture only)	7060A2009
400SC	Safety cable	7060A1022
400PH-A	Pattern holder (A size)	7060A1013
400PH-B	Pattern holder (B size)	7060A1014
400PH-G	Glass pattern holder	7060A1019
400RS	Drop-in iris	7060A1012
S4LED-SB	Standard/EDLT Source Four LED shutter barrel	7460A2007
S4LEDBY	Source Four LED balance yoke assembly	7462A2021-K

## Other Accessories

TYPE	445 MM / 17.5 IN		355 MM / 14 IN		255 MM / 10 IN		190 MM / 7.5 IN		159 MM / 6.25 IN	
	Model	Part No.	Model	Part No.	Model	Part No.	Model	Part No.	Model	Part No.
Top Hat	TH17.5	PSF1194	405TH	PSF1025	TH10	PSF1198	400PTH6	PSF1023	400TH	PSF1021
Half Hat	HH17.5	PSF1195			HH10	PSF1199	400PHH	PSF1027	400HH	PSF1026
Color Frame	CF17.5	PSF1196	405CF	7060A3070	CF10	PSF1201	407CF	7061A3007	400CF	7060A3043
Donut	DN17.5	PSF1197	405DN	7060A1029	DN10	PSF1200	407DN	7060A1016	400DN	7060A1015

## Power Input Cables

Use information below to order 5 ft power input leads with factory-fitted connectors. CE fixtures ship with 2 m powerCON TRUE1 TOP to bare end (2500B7035).

MODEL	DESCRIPTION	PART NUMBER (NOT CE)
T1PA-A	5 ft TRUE1 TOP to parallel blade U-ground (Edison) connector (ETL only)	2500B7029-A
T1PA-B	5 ft TRUE1 TOP to 20 A two-pin and ground (stage-pin) connector (ETL only)	2500B7029-B
T1PA-C	5 ft TRUE1 TOP to grounded 20 A twistlock connector (ETL only)	2500B7029-C
T1PA-X	5 ft TRUE1 TOP to bare-end power input lead (ETL only)	2500B7029-X

Note: One cable of your choice is included with each fixture.

## Power Thru Jumpers

Power thru jumpers connect to output (thru) connectors to provide power to successive luminaires inline.

MODEL	DESCRIPTION	PART NUMBER
T1PJ-5	5 ft TRUE1 TOP to TRUE1 TOP fixture to fixture jumper (ETL only)	2500B7030
T1PJ-10	10 ft TRUE1 TOP to TRUE1 TOP fixture to fixture jumper (ETL only)	2500B7031

## Diffusers

MODEL	DESCRIPTION	PART NUMBER
S4LED-SFD	Source Four LED - Soft focus diffuser	7460A4019
S4LED-SWD6	Source Four LED - Smooth wash diffuser for 6.25 in gel frame slots	7460K1001
S4LED-SWD7	Source Four LED - Smooth wash diffuser for 7.5 in gel frame slots	7460K1002
S4LED-SWD10	Source Four LED - Smooth wash diffuser for 10 in gel frame slots	7462K1018
S4LED-SWD12	Source Four LED - Smooth wash diffuser for 12 in gel frame slots	7460K1003
S4LED-SWD14	Source Four LED - Smooth wash diffuser for 14 in gel frame slots	7460K1004

The Soft Focus Diffuser fits into a standard A-Size pattern holder and delivers beautiful homogenized light when not in sharp focus. Also, use with patterns for dappled and soft-edge projections.

The Smooth Wash Diffuser is used when extra-smooth blending of multiple Source Four LED fixtures is required. The smooth wash diffuser is placed into the gel-frame slot of the lens tube.

PHYSICAL

	WEIGHT		SHIPPING WEIGHT	
	kg	lb	kg	lb
With Barrel	8.87	19.55	10.61	23.4
Without Barrel	6.76	14.90	8.30	18.3

\*Does not include mounting hardware or lens tube

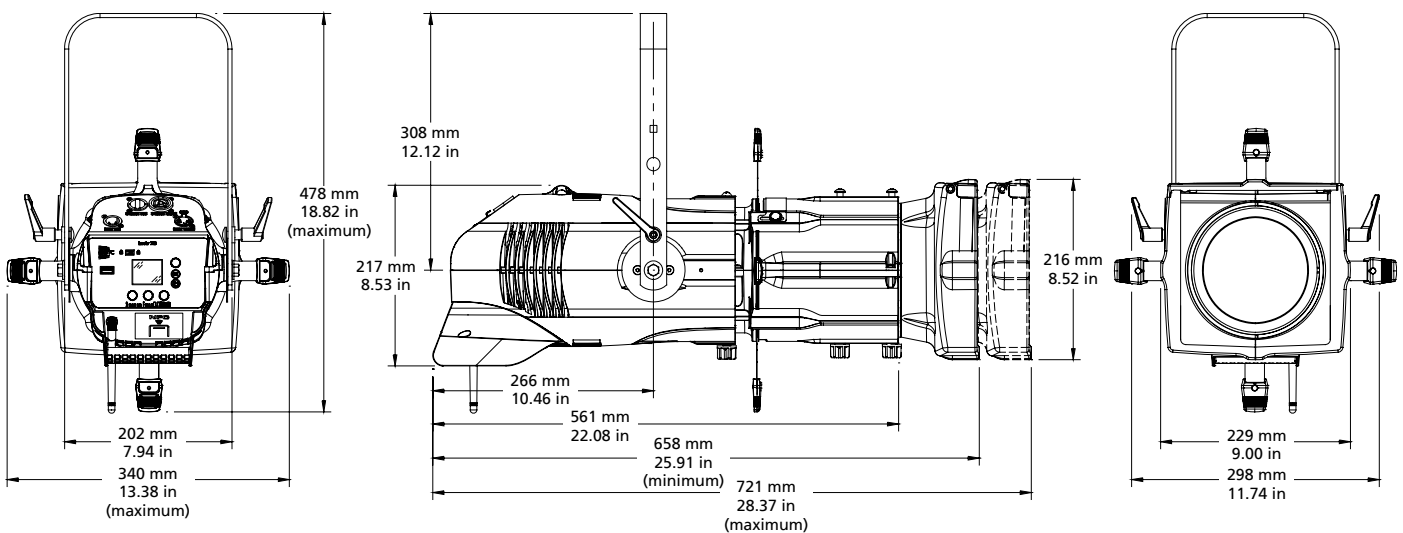

Corporate Headquarters • Middleton, WI USA

Global Offices • London, UK • Rome, IT • Holzkirchen, DE • Paris, FR • Hong Kong  
Dubai, UAE • Singapore • New York, NY • Orlando, FL • Los Angeles, CA • Austin, TX

Copyright©2023 ETC. All Rights Reserved. All product information and specifications subject to change. Rev F 2023-03

\*Trademark and patent info: [etcconnect.com/IE](http://etcconnect.com/IE)

[etcconnect.com](http://etcconnect.com)